



2024



Commel[®]

Kabelske motalice - heavy duty line Cable Reels - Heavy Duty Line 8	Utikači, natikači i utičnice Plugs, Connectors and Sockets 68	Izolacijski pribor Insulation Accessories 132	LED vodotijesne svjetiljke LED Waterproof Light Fixtures 180
Kabelske motalice - profi line Cable Reels - Profi Line 14	Razdjelnici, adapteri i blokade Adaptors and Direct contact protection 74	Tuljci i stopice Wire Terminals 136	Panik svjetiljke Emergency Light Fixtures 184
Kabelske motalice - hobby line Cable Reels - Hobby Line 22	Kućna automatizacija Home Automation 80	Električarski alati Hand Tools 140	Solarni LED reflektori Solar LED Floodlights 186
Razdjelni ormari Mobile Power Stations 28	Multimetri i ispitivači napona Multimeters and Voltage Testers 92	LED žarulje LED Bulbs 148	LED reflektori LED Floodlights 190
Priključni kabeli Connection Cables 30	Zvonca Doorbells 96	LED Trake LED Strip Lights 154	Akumulatorski LED reflektori Rechargeable LED Floodlights 196
Produžni kabeli - profi line Extension Cables - Profi Line 34	Portafoni Door Phones 102	Zidne i stropne LED svjetiljke LED Under Cabinet Light Fixtures 156	Radne i prenosive svjetiljke Inspection and Portable Lamps 198
Produžni kabeli - hobby line Extension Cables - Hobby Line 44	Ventilatori Exhaust Fans 106	Zidne i stropne svjetiljke Bulkhead Light Fixtures 162	Noćna svjetla Night Lights 204
Prenaponska zaštita Surge Protection 48	Automatski osigurači i FID sklopke RCD Switch and Miniature Circuit Breaker 110	LED plafonjere LED Ceiling Lamps 164	Detektori pokreta i luksomati Motion Detectors and Photocell Sensors 206
Prenosive utičnice Extension Sockets 52	Kućni prekidači i utičnice Home Swithes and Sockets 112	LED paneli LED Panels 168	Grla i pribor za rasvjetu Bulb Sockets and Lighting Accessories 210
Ugradbene utičnice za namještaj Furniture Sockets 58	Montažni pribor Mounting Accessories 116	LED ugradbene svjetiljke LED Downlights 176	Izlaganje asortimana Point of Sale Display Units 214
Industrijski utikači, natikači i utičnice CEE Plugs, Connectors and Sockets 62	Spojni pribor Connection Accessories 122	LED cijevi LED Tubes 178	

OZNAKE I NAMJENA KABELA U KATALOGU

CODES AND USAGE GUIDE FOR CABLES IN THE CATALOGUE

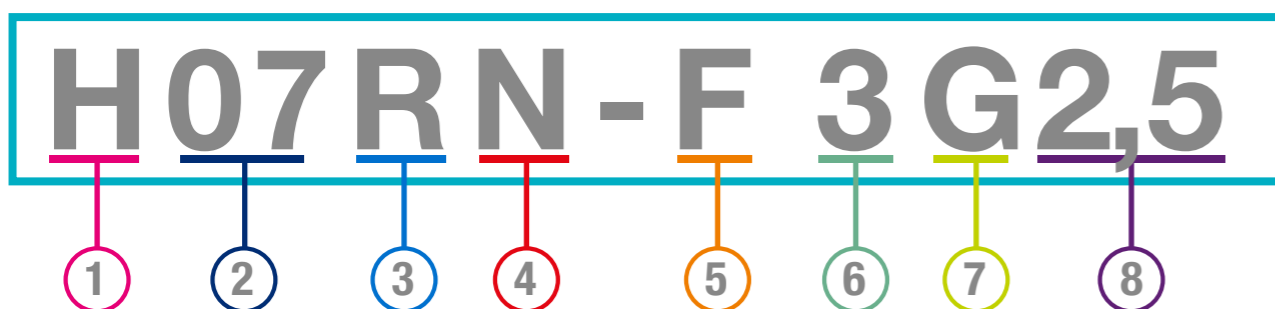

1 VEZA SA STANDARDOM IDENTIFICATION OF DESIGNATION

H - Harmonizirani standardi
Harmonized standards
A - Autorizirani nacionalni standardi
Authorized national standards

4 MATERIJAL PLAŠTA SHEAT MATERIAL

V - PVC - polivinilklorid
Polyvinylchlorid
V3 - PVC - polivinilklorid, otporan na nisku temperaturu
Polyvinylchlorid, low temperature resistant
R - prirodni ili umjetni kaučuk
Natural or synthetic rubber
N - polikloroprenski kaučuk
Polychloroprene rubber
T - oplet od pamuka
Textile braid over twisted cores
Q - termoplastična poliuretanska guma
Thermoplastic polyurethane rubber

5 VRSTA VODIČA CONDUCTOR TYPE

F - fleksibilni za savitljive vodove
Flexible for flexible cords

6 BROJ VODIČA NUMBER OF CORES

7 UZEMLJENJE PROTECTIVE CONDUCTOR

G - sa zeleno / žutim vodičem
With green / yellow core
X - bez zeleno / žutog vodiča
Without green / yellow core

2 NAZIVNI NAPON NOMINAL VOLTAGE

01 - 100 V
03 - 300 / 300 V
05 - 300 / 500 V
07 - 450 / 750 V

3 IZOLACIJSKI MATERIJAL INSULATION MATERIALS

V - PVC - polivinilklorid
Polyvinylchlorid
V3 - PVC - polivinilklorid, otporan na nisku temperaturu
Polyvinylchlorid, low temperature resistant
R - prirodni ili umjetni kaučuk
Natural or synthetic rubber
B - elastomerna etilen-propilenska guma
Elastomeric Ethylene-Propylene rubber

8 POPREČNI PRESJEK VODIČA u mm² CONDUCTOR NOMINAL CROSS SECTION in mm²



H07BQ-F

Namjena:
Za trajnu vanjsku upotrebu u vlažnim i suhim uvjetima, pri temperaturama od -40°C do +90°C.

Karakteristike:
Visoka fleksibilnost do -40°C. Izvrsna otpornost na mehanička opterećenja, habanje, vremenske prilike, niske temperature, vodu, ulja i masti.

Use:
For long-term outdoor use in wet and dry conditions, at temperatures from -40°C to +90°C.

Characteristics:
High flexibility even at temperatures low as -40°C. Excellent resistance to mechanical and tear stress, weather conditions, low temperatures, water, oils and greases.



H07RN-F

Namjena:
Za trajnu vanjsku upotrebu u vlažnim i suhim uvjetima, pri temperaturama od -25°C do +60°C.

Karakteristike:
Visoka fleksibilnost i otpornost na ulja, kiseline, vremenske prilike, niske temperature i velika mehanička opterećenja.

Use:
For long-term outdoor use in wet and dry conditions, at temperatures from -25°C to +60°C.

Characteristics:
High flexibility and resistance to oils, acids, weather conditions, low temperatures and high mechanical stress.



AT N07V3V3-F

Namjena:
Za trajnu vanjsku upotrebu u vlažnim i suhim uvjetima, pri temperaturama od -35°C do +70°C.

Karakteristike:
Otpornost na ulja, velika mehanička opterećenja i niske temperature. Visoka fleksibilnost pri temperaturama do čak -35°C.

Use:
For long-term outdoor use in wet and dry conditions, at temperatures from -35°C to +70°C.

Characteristics:
Resistance to oils, high mechanical stress and low temperatures. High flexibility even at temperatures as low as -35°C.



H05RR-F

Namjena:
Za privremenu vanjsku upotrebu, pri temperaturama od -25°C do +60°C.

Karakteristike:
Visoka fleksibilnost i otpornost na manja mehanička opterećenja.

Use:
For short-term outdoor use at temperatures from -25°C to +60°C.

Characteristics:
High flexibility and resistance to low mechanical stress.



H05VV-F

Namjena:
Za svakodnevnu upotrebu u suhim uvjetima, pri temperaturama od +5°C do +70°C.

Karakteristike:
Visoka fleksibilnost i otpornost na manja mehanička opterećenja.

Use:
For everyday use in dry conditions, at temperatures from +5°C to +70°C.

Characteristics:
High flexibility and resistance to low mechanical stress.

DOŽIVOTNO JAMSTVO

Commel kabelske motalice se već dugi niz godina ističu svojom **kvalitetom** i pouzdanošću. Zahvaljujući širokom asortimanu, svaki će korisnik u našoj ponudi pronaći **idealnu** kabelsku motalicu za svoje potrebe. Proizvodi iz ove kategorije opremljeni su **vrhunskim** komponentama, ručno su sastavljeni i pažljivo prekontrolirani prije isporuke. Svaki pojedini artikl prolazi završno ispitivanje po sistemu dvostruke kontrole, te je označen serijskim brojem radi osiguravanja sljedivosti. Kao dodatnu **sigurnost**, od sada svim kupcima Commel kabelskih motalica dajemo DOŽIVOTNO JAMSTVO. Kupnjom Commel kabelske motalice dobivate vrhunski proizvod europske kvalitete koji ćete koristiti **doživotno**.

Što je pokriveno Commel doživotnim jamstvom?

Commel doživotno jamstvo pokriva sve tvorničke greške, nedostatke u materijalu ili nedostatke u izradi koji mogu utjecati na funkciju proizvoda, a koji su uočeni pri normalnoj upotrebi i poštivanju svih tehničkih specifikacija proizvoda.

Koliko traje jamstvo?

Doživotno! Ovdje nema trikova ni sitnih slova. Doživotno jamstvo doslovno i znači doživotno jamstvo! Jamstvo vrijedi do kraja životnog vijeka svake osobe koja kupi kabelsku motalicu Commel sa oznakom doživotnog jamstva i registrira se na našim web stranicama.

Kako aktivirati jamstvo?

Za aktivaciju doživotnog jamstva potrebno je registrirati proizvod u roku trideset (30) dana od dana kupnje. Obrazac za registraciju proizvoda nalazi se na linku: <http://www.commel.hr/aktivacija-jamstva/>
Nakon registracije ćete dobiti Vaš osobni certifikat doživotnog jamstva.

Tko može koristiti doživotno jamstvo?

Commel doživotno jamstvo može koristiti isključivo originalni kupac proizvoda. Jamstvo nije prenosivo na druge osobe.

LIFETIME WARRANTY

Commel cable reels have been well known for their quality and **safety** for many years. Thanks to a wide assortment, every user can find the **ideal** cable reel for their needs. The products from this category are equipped with **top quality** components, hand-assembled and carefully checked before delivery. During the production, each item passes through the double checking system before the final **quality** control check and is marked with a serial number to ensure the traceability.

To prove our confidence in their quality and safety, we now **provide** LIFETIME WARRANTY to all buyers of Commel cable reels. Purchasing the Commel cable reels, you get a top quality European product you will use for a **lifetime**.

What is covered under the Commel Lifetime Warranty?

Commel Lifetime Warranty covers all manufacturing defects, as well as defects in materials and workmanship that may affect the function of the product, which are noticed when used in normal conditions and in accordance with all technical specifications of the product.

How long the warranty lasts?

A lifetime! There are no tricks or small print here. Lifetime Warranty literally means lifetime warranty! It means that it covers a lifetime of any person who buys the Commel cable reel with a Lifetime Warranty mark and is registered on our web site.

How to activate the Lifetime Warranty?

To activate the Lifetime Warranty, you must register the product within thirty (30) days from the date of purchase. The product registration form is available on the following link: <http://www.commel.hr/en/warranty-activation/>
After the registration you will receive your personal Lifetime Warranty Certificate.

Who can use this Lifetime Warranty?

Commel Lifetime Warranty can only be used by the original buyer of the product. The warranty is not transferable to other persons.



Commel®

HEAVY DUTY LINE

Kabelske motalice

Ugradnjom vrhunskih komponenti i korištenjem najotpornijih kabela stvorili smo liniju proizvoda namijenjenu profesionalnim korisnicima u najzahtjevnijim uvjetima rada. Heavy duty line kabelske motalice odlikuju otpornost na sve vremenske uvjete, vlagu, visoke i niske temperature i velika mehanička opterećenja.

Cable Reels

With top quality components and the most resistant cables, we have created a product line for professional use in the most demanding conditions.

Heavy Duty Line cable reels are resistant to all weather conditions, humidity, high and low temperatures and high mechanical stress.



HEAVY DUTY LINE

KABELSKE MOTALICE | CABLE REELS



- Utičnice s poklopcem omogućavaju stupanj zaštite IP44**
 Sockets with lid provide IP44 degree of protection
- Kočnica koja sprječava nekontrolirano odmatanje kabela**
 Brake mechanism that prevents the cable from accidental unwinding
- Ugrađena zaštita od preopterećenja – termoprekidač**
 Built-in overload protection – thermo switch



AVAILABLE STANDARDS

SCHUKO / TYPE F

FRENCH / TYPE E

BRITISH / TYPE G

Šifra / Art. No.	Kabel / Cable	Dužina kabela / Cable length	Boja kabela / Cable color	Utičnice / Sockets	Utičać / Plug	Promjer motalice / Reel diameter	Stupanj zaštite / IP grade	Kom./kutija / Pcs/cdn	EAN
200-395	H07BQ-F 5G2,5	25 m	narančasta / orange	1 x CEE 400 V~ / 16 A 2 x 230 V~ / 16 A	CEE 400 V~ / 16 A	280 mm	IP44	1	3856024405560
200-390	H07RN-F 5G2,5	25 m	crna / black	1 x CEE 400 V~ / 16 A 2 x 230 V~ / 16 A	CEE 400 V~ / 16 A	280 mm	IP44	1	3858890447644
200-391	AT N07V3V3-F 5G2,5	25 m	žuta / yellow	1 x CEE 400 V~ / 16 A 2 x 230 V~ / 16 A	CEE 400 V~ / 16 A	280 mm	IP44	1	3858890444506
200-396	H07BQ-F 5G1,5	40 m	narančasta / orange	1 x CEE 400 V~ / 16 A 2 x 230 V~ / 16 A	CEE 400 V~ / 16 A	280 mm	IP44	1	3856024405577
200-392	H07RN-F 5G1,5	40 m	crna / black	1 x CEE 400 V~ / 16 A 2 x 230 V~ / 16 A	CEE 400 V~ / 16 A	280 mm	IP44	1	3858890447651

Commel®



MADE IN EUROPE

MADE IN EUROPE



- **Utičnice s poklopcem omogućavaju stupanj zaštite IP44**
 Sockets with lid provide IP44 degree of protection
- **Kočnica koja sprječava nekontrolirano odmatanje kabela**
 Brake mechanism that prevents the cable from accidental unwinding
- **Ugrađena zaštita od preopterećenja – termoprekidač**
 Built-in overload protection – thermo switch

- **Utičnice s poklopcem omogućavaju stupanj zaštite IP44**
 Sockets with lid provide IP44 degree of protection
- **Ugrađena zaštita od preopterećenja – termoprekidač**
 Built-in overload protection – thermo switch
- **Rotirajuća ergonomska ručica**
 Rotating ergonomic handle

ANTI-TWIST TECHNOLOGY



Šifra / Art. No.	Kabel / Cable	Dužina kabela / Cable length	Boja kabela / Cable color	Utičnice / Sockets	Utičak / Plug	Promjer motalice / Reel diameter	Stupanj zaštite / IP grade	Kom./kutija / Pcs./ctn	EAN
200-393	H07RN-F 5G2,5	25 m	crna / black	1 x 400 V~ / 16 A 2 x 230 V~ / 16 A	400 V~ / 16 A	280 mm	IP44	1	3858890447668
200-394	AT N07V3V3-F 5G2,5	25 m	žuta / yellow	1 x 400 V~ / 16 A 2 x 230 V~ / 16 A	400 V~ / 16 A	280 mm	IP44	1	3858890447675
0934	H05RR-F 5G2,5	25 m	crna / black	1 x 400 V~ / 16 A 2 x 230 V~ / 16 A	400 V~ / 16 A	280 mm	IP44	1	3859888761971

Šifra / Art. No.	Kabel / Cable	Dužina kabela / Cable length	Boja kabela / Cable color	Utičnice / Sockets	Utičak / Plug	Promjer motalice / Reel diameter	Stupanj zaštite / IP grade	Kom./kutija / Pcs./ctn	EAN
200-383	H07BQ-F 3G1,5	50 m	narančasta / orange	4 x 230 V~ / 16 A	230 V~ / 16 A	300 mm	IP44	1	3856024405584
200-381	H07RN-F 3G1,5	50 m	crna / black	4 x 230 V~ / 16 A	230 V~ / 16 A	300 mm	IP44	1	3858890447590
200-382	AT N07V3V3-F 3G1,5	50 m	žuta / yellow	4 x 230 V~ / 16 A	230 V~ / 16 A	300 mm	IP44	1	3858890447606



- Utičnice s poklopcem omogućavaju stupanj zaštite IP44
Sockets with lid provide IP44 degree of protection
- Ugrađena zaštita od preopterećenja – termoprekidač
Built-in overload protection – thermo switch
- Rotirajuća ergonomska ručica
Rotating ergonomic handle
- Svjetlosni indikator napona
Power indicator light

MADE IN EUROPE

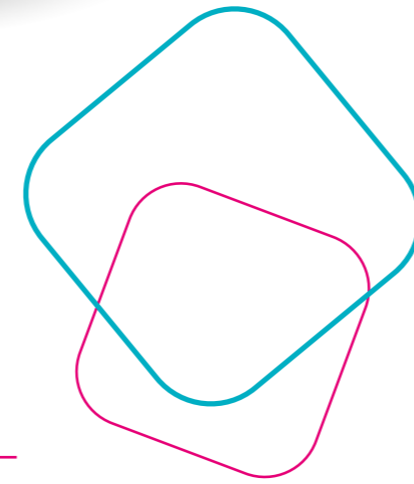

Šifra / Art. No.	Kabel / Cable	Dužina kabela / Cable length	Boja kabela / Cable color	Utičnice / Sockets	Utičać / Plug	Promjer motalice / Reel diameter	Stupanj zaštite / IP grade	Kom./kutija / Pcs/ctn	EAN
200-375	H07BQ-F 3G2,5	40 m	narančasta / orange	4 x 230 V~ / 16 A	230 V~ / 16 A	300 mm	IP44	1	3856024405591
0983	H07RN-F 3G2,5	40 m	crna / black	4 x 230 V~ / 16 A	230 V~ / 16 A	300 mm	IP44	1	3858883831542
200-363	AT N07V3V3-F 3G2,5	40 m	žuta / yellow	4 x 230 V~ / 16 A	230 V~ / 16 A	300 mm	IP44	1	3858890444513
200-376	H07BQ-F 3G1,5	50 m	narančasta / orange	4 x 230 V~ / 16 A	230 V~ / 16 A	300 mm	IP44	1	3856024405607
200-364	H07RN-F 3G1,5	50 m	crna / black	4 x 230 V~ / 16 A	230 V~ / 16 A	300 mm	IP44	1	3858890447705
200-365	AT N07V3V3-F 3G1,5	50 m	žuta / yellow	4 x 230 V~ / 16 A	230 V~ / 16 A	300 mm	IP44	1	3858890447712
200-377	H07BQ-F 3G1,5	30 m	narančasta / orange	4 x 230 V~ / 16 A	230 V~ / 16 A	300 mm	IP44	1	3856024405614
200-366	H07RN-F 3G1,5	30 m	crna / black	4 x 230 V~ / 16 A	230 V~ / 16 A	300 mm	IP44	1	3858890447729
200-367	AT N07V3V3-F 3G1,5	30 m	žuta / yellow	4 x 230 V~ / 16 A	230 V~ / 16 A	300 mm	IP44	1	3858890447736



- Utičnice s poklopcem omogućavaju stupanj zaštite IP44
Sockets with lid provide IP44 degree of protection
- Ugrađena zaštita od preopterećenja – termoprekidač
Built-in overload protection – thermo switch
- Rotirajuća ergonomska ručica
Rotating ergonomic handle
- Svjetlosni indikator napona
Power indicator light
- Metalni bubanj
Metal reel

MADE IN EUROPE



AVAILABLE STANDARDS

SCHUKO / TYPE F

FRENCH / TYPE E

BRITISH / TYPE G

Šifra / Art. No.	Kabel / Cable	Dužina kabela / Cable length	Boja kabela / Cable color	Utičnice / Sockets	Utičać / Plug	Promjer motalice / Reel diameter	Stupanj zaštite / IP grade	Kom./kutija / Pcs/ctn	EAN
200-378	H07BQ-F 3G2,5	50 m	narančasta / orange	3 x 230 V~ / 16 A	230 V~ / 16 A	280 mm	IP44	1	3856024405621
200-379	H07BQ-F 3G1,5	50 m	narančasta / orange	3 x 230 V~ / 16 A	230 V~ / 16 A	280 mm	IP44	1	3856024405638
200-321	H07RN-F 3G2,5	50 m	crna / black	3 x 230 V~ / 16 A	230 V~ / 16 A	280 mm	IP44	1	3856024401234
200-322	H07RN-F 3G1,5	50 m	crna / black	3 x 230 V~ / 16 A	230 V~ / 16 A	280 mm	IP44	1	3856024401241
200-323	AT N07V3V3 3G2,5	40 m	žuta / yellow	3 x 230 V~ / 16 A	230 V~ / 16 A	280 mm	IP44	1	3856024401258
200-324	AT N07V3V3 3G1,5	50 m	žuta / yellow	3 x 230 V~ / 16 A	230 V~ / 16 A	280 mm	IP44	1	3856024401265



Kabelske motalice

...za beskompromisne korisnike koji traže samo vrhunsku kvalitetu i neupitnu pouzdanost u svim uvjetima rada. Robusnost kućišta, bubnja, utičnica, kabela i ostalih komponenti je ono što ove motalice čini posebnima. Često se susrećemo sa Commel profi kabelskim motalicama koje se koriste i više od 20 godina. Napravljeno da traje!

Cable Reels

...for uncompromising users seeking only top quality and unmatched reliability under all operating conditions. The robustness of the housing, drum, sockets, cable, and other components is what makes these reels special. You can often come across Commel Profi Line cable reels that have been used for more than 20 years. Made to last!

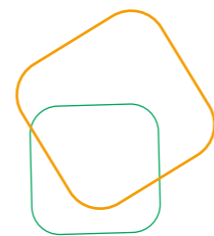

MADE IN EUROPE



- **Utičnice s poklopcem omogućavaju stupanj zaštite IP44**
Sockets with lid provide IP44 degree of protection
- **Rotirajuća ergonomska ručica**
Rotating ergonomic handle
- **Ugrađena zaštita od preopterećenja – termoprekidač**
Built-in overload protection – thermo switch
- **Svjetlosni indikator napona**
Power indicator light

Šifra / Art. No.	Kabel / Cable	Dužina kabela / Cable length	Boja kabela / Cable color	Utičnice / Sockets	Utičak / Plug	Promjer motalice / Reel diameter	Stupanj zaštite / IP grade	Kom./Kutija / Pcs/Ctn	EAN
0912	H05W-F 3G2,5	50 m	crna / black	4 x 230 V~ / 16 A	230 V~ / 16 A	300 mm	IP44	1	3859888558779
0932	H05RR-F 3G2,5	50 m	crna / black	4 x 230 V~ / 16 A	230 V~ / 16 A	300 mm	IP44	1	3859888558854



MADE IN EUROPE

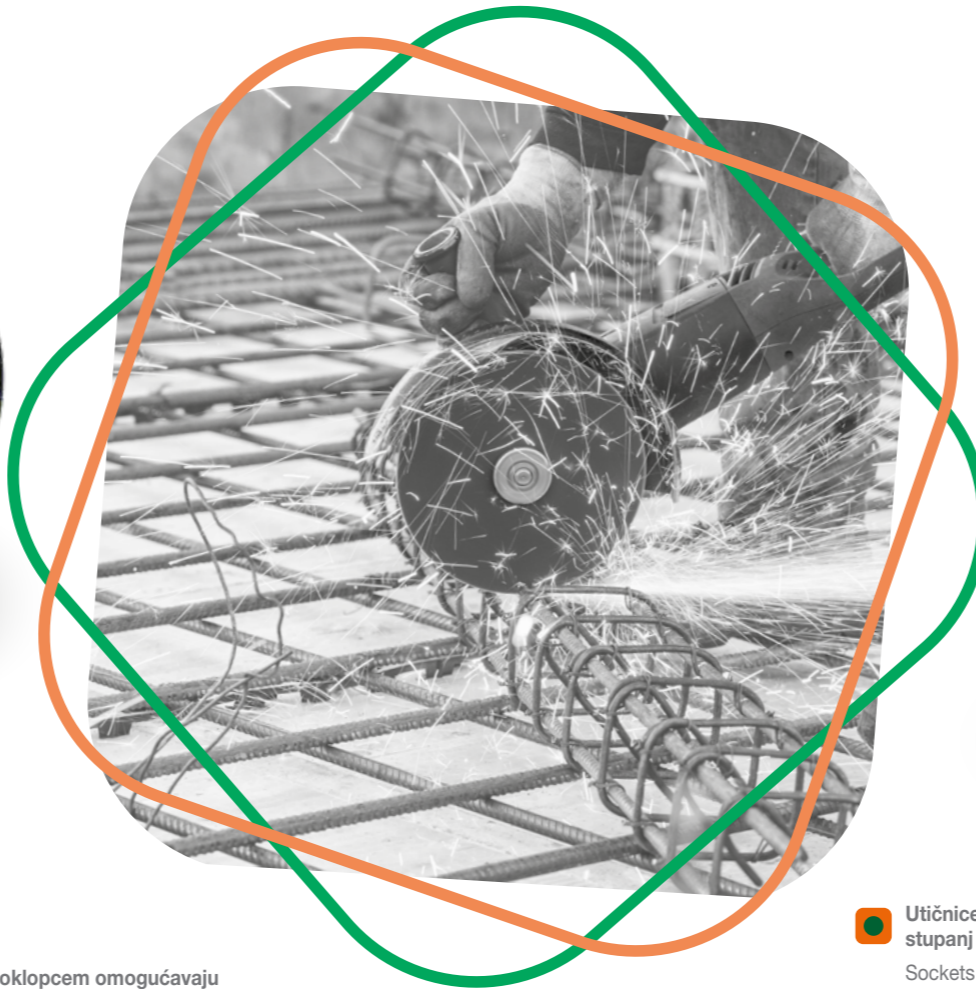

MADE IN EUROPE



- **Utičnice s poklopcem omogućavaju stupanj zaštite IP44**
 Sockets with lid provide IP44 degree of protection
- **Ugrađena zaštita od preopterećenja – termoprekidač**
 Built-in overload protection – thermo switch
- **Svjetlosni indikator napona**
 Power indicator light

AVAILABLE STANDARDS

○ SCHUKO / TYPE F
 ○ FRENCH / TYPE E
 ○ BRITISH / TYPE G

Šifra / Art. No.	Kabel / Cable	Dužina kabala / Cable length	Boja kabala / Cable color	Utičnice / Sockets	Utičnik / Plug	Promjer motalice / Reel diameter	Stupanj zaštite / IP grade	Kom./kutija / Pcs./ctn	EAN
200-360	H07RN-F 3G2,5	40 m	crna / black	3 x 230 V~ / 16 A	230 V~ / 16 A	280 mm	IP44	1	3858890447743
200-373	H07RN-F 3G2,5	25 m	crna / black	3 x 230 V~ / 16 A	230 V~ / 16 A	280 mm	IP44	1	3856024405546
0982	H05RR-F 3G2,5	40 m	crna / black	3 x 230 V~ / 16 A	230 V~ / 16 A	280 mm	IP44	1	3859889306973
0980	H05RR-F 3G2,5	25 m	crna / black	3 x 230 V~ / 16 A	230 V~ / 16 A	280 mm	IP44	1	3859889306966
200-368	H05RR-F 3G1,5	50 m	crna / black	3 x 230 V~ / 16 A	230 V~ / 16 A	280 mm	IP44	1	3858890447750
200-369	H05RR-F 3G1,5	25 m	crna / black	3 x 230 V~ / 16 A	230 V~ / 16 A	280 mm	IP44	1	3858890447767
200-371	AT N07V3V3-F 3G2,5	25 m	žuta / yellow	3 x 230 V~ / 16 A	230 V~ / 16 A	280 mm	IP44	1	3856024403474
200-362	AT N07V3V3-F 3G1,5	40 m	žuta / yellow	3 x 230 V~ / 16 A	230 V~ / 16 A	280 mm	IP44	1	3858890444520
200-361	AT N07V3V3-F 3G1,5	25 m	žuta / yellow	3 x 230 V~ / 16 A	230 V~ / 16 A	280 mm	IP44	1	3858890444537
200-370	H05RR-F 3G1,5	15 m	crna / black	3 x 230 V~ / 16 A	230 V~ / 16 A	230 mm	IP44	1	3858890447774

- **Utičnice s poklopcem omogućavaju stupanj zaštite IP44**
 Sockets with lid provide IP44 degree of protection
- **Ugrađena zaštita od preopterećenja – termoprekidač**
 Built-in overload protection – thermo switch
- **Svjetlosni indikator napona**
 Power indicator light

- **Rotirajuća ergonomska ručica**
 Rotating ergonomic handle
- **Metalni bubanj**
 Metal reel





AVAILABLE STANDARDS

○ SCHUKO / TYPE F
 ○ FRENCH / TYPE E
 ○ BRITISH / TYPE G

Šifra / Art. No.	Kabel / Cable	Dužina kabala / Cable length	Boja kabala / Cable color	Utičnice / Sockets	Utičnik / Plug	Promjer motalice / Reel diameter	Stupanj zaštite / IP grade	Kom./kutija / Pcs./ctn	EAN
200-340	H07RN-F 3G2,5	40 m	crna / black	3 x 230 V~ / 16 A	230 V~ / 16 A	280 mm	IP44	1	3858890447781
200-374	H07RN-F 3G2,5	25 m	crna / black	3 x 230 V~ / 16 A	230 V~ / 16 A	280 mm	IP44	1	3856024405553
0930	H05RR-F 3G2,5	40 m	crna / black	3 x 230 V~ / 16 A	230 V~ / 16 A	280 mm	IP44	1	3859889306959
0928	H05RR-F 3G2,5	25 m	crna / black	3 x 230 V~ / 16 A	230 V~ / 16 A	280 mm	IP44	1	3859889306942
200-341	H05RR-F 3G1,5	50 m	crna / black	3 x 230 V~ / 16 A	230 V~ / 16 A	280 mm	IP44	1	3858890447798
200-342	H05RR-F 3G1,5	25 m	crna / black	3 x 230 V~ / 16 A	230 V~ / 16 A	280 mm	IP44	1	3858890447804
200-372	AT N07V3V3-F 3G2,5	25 m	žuta / yellow	3 x 230 V~ / 16 A	230 V~ / 16 A	280 mm	IP44	1	3856024403481
200-343	AT N07V3V3-F 3G1,5	40 m	žuta / yellow	3 x 230 V~ / 16 A	230 V~ / 16 A	280 mm	IP44	1	3858890447811
200-344	AT N07V3V3-F 3G1,5	25 m	žuta / yellow	3 x 230 V~ / 16 A	230 V~ / 16 A	280 mm	IP44	1	3858890447828



MADE IN EUROPE

-  **Utičnice s poklopcem omogućavaju stupanj zaštite IP44**
Sockets with lid provide IP44 degree of protection
-  **Ugrađena zaštita od preopterećenja – termoprekidač**
Built-in overload protection – thermo switch
-  **Svjetlosni indikator napona**
Power indicator light
-  **Metalni bubanj**
Metal reel
-  **Rotirajuća ergonomska ručica**
Rotating ergonomic handle





Konstrukcija prilagođena za izvođenje profesionalnih radova, kao i za hobi korisnike. Utičnice se nalaze na kraju kabela, stoga nema potrebe za premještanjem motalice za vrijeme obavljanja radova.

Construction designed for professional as well as for hobby users. Sockets are at the end of the cable, so there is no need to move around the cable reel during the work.

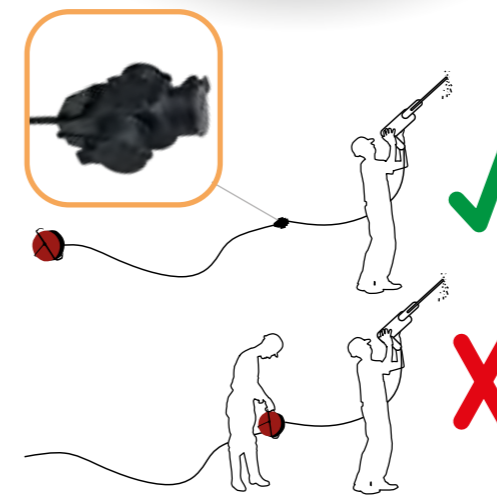

MADE IN EUROPE



-  **Ugrađena zaštita od preopterećenja – termoprekidač**
Built-in overload protection – thermo switch
-  **Svjetlosni indikator napona**
Power indicator light
-  **Gumirani trostruki razdjelnik otporan na udarce**
Shock resistant rubber 3-way socket outlet

AVAILABLE STANDARDS	 SCHUKO / TYPE F	 FRENCH / TYPE E	 BRITISH / TYPE G
---------------------	---	---	--

Šifra / Art. No.	Kabel / Cable	Dužina kabela / Cable length	Boja kabela / Cable color	Utičnice / Sockets	Utičak / Plug	Promjer motalice / Reel diameter	Stupanj zaštite / IP grade	Kom. /Kutija / Pcs/ctn	EAN
200-325	H05RR-F 3G2,5	50 m	crna / black	3 x 230 V~ / 16 A	230 V~ / 16 A	280 mm	IP44	1	3856024401272
200-326	H05RR-F 3G1,5	50 m	crna / black	3 x 230 V~ / 16 A	230 V~ / 16 A	280 mm	IP44	1	3856024401289

Šifra / Art. No.	Kabel / Cable	Dužina kabela / Cable length	Boja kabela / Cable color	Utičnice / Sockets	Utičak / Plug	Promjer motalice / Reel diameter	Stupanj zaštite / IP grade	Kom. /Kutija / Pcs/ctn	EAN
200-313	H07RN-F 3G1,5	40 m	crna / black	3 x 230 V~ / 16 A	230 V~ / 16 A	280 mm	IP44	1	3858890447835
0945	H05RR-F 3G1,5	50 m	crna / black	3 x 230 V~ / 16 A	230 V~ / 16 A	280 mm	IP44	1	3858883834222
0944	H05RR-F 3G1,5	25 m	crna / black	3 x 230 V~ / 16 A	230 V~ / 16 A	280 mm	IP44	1	3858883834260
200-312	AT N07V3V3-F 3G1,5	40 m	žuta / yellow	3 x 230 V~ / 16 A	230 V~ / 16 A	280 mm	IP44	1	3858890444544
200-311	AT N07V3V3-F 3G1,5	25 m	žuta / yellow	3 x 230 V~ / 16 A	230 V~ / 16 A	280 mm	IP44	1	3858890444551



Konstrukcija motalice je prilagođena za upotrebu s vrtnim električnim alatima. Utičnica se nalazi na kraju kabela, stoga nema potrebe za premještanjem motalice za vrijeme obavljanja radova.

The construction of the reel is designed for use with garden power tools. The socket is at the end of the cable so there is no need to move around the cable reel during the work.



- Ugrađena zaštita od preopterećenja - termoprekidač
Built-in overload protection - thermo switch
- Svjetlosni indikator napona
Power indicator light
- PVC ručica
PVC handle

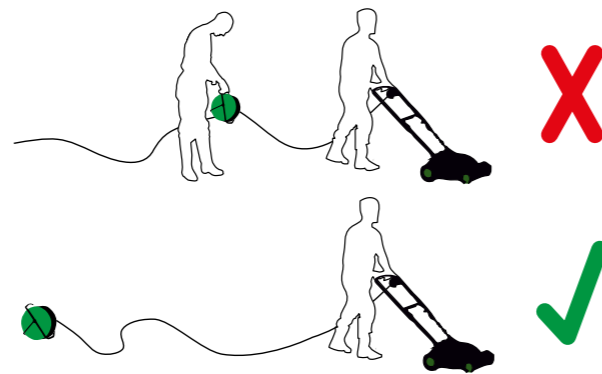

Šifra / Art. No.	Kabel / Cable	Dužina kabela / Cable length	Boja kabela / Cable color	Utičnice / Sockets	Utičać / Plug	Promjer motalice / Reel diameter	Stupanj zaštite / IP grade	Kom./Kutija / Pcs./ctn	EAN
200-351	AT N07V3V3-F 3G1,5	25 m	žuta / yellow	1 x 230 V~ / 16 A	230 V~ / 16 A	280 mm	IP44	1	3858890447842
200-352	AT N07V3V3-F 3G1,5	40 m	žuta / yellow	1 x 230 V~ / 16 A	230 V~ / 16 A	280 mm	IP44	1	3858890447859



Commel MARINKO grupa proizvoda je opremljena specijalnim MarinFlex kablom otpornim na abrazivna djelovanja morske vode. MarinFlex kabl moguće je koristiti u uvjetima trajnog ili povremenog kontakta s morskom vodom, a odlikuju ga izvrsna fleksibilnost i otpornost na visoke i niske temperature. Posebno je pogodan za električni priključak plovila u marinama jer je jednostavan za održavanje, lako se čisti i ne ostavlja tragove na površinama.

The Commel MARINKO product group is equipped with a special MarinFlex cable resistant to the abrasive action of sea water. The MarinFlex cable can be used in conditions of permanent or occasional contact with sea water, and it has excellent flexibility and resistance to high and low temperatures. It is especially suitable for the electrical connection of boats in the marinas because it is easy to maintain, easy to clean and leaves no traces on the surfaces.

Upotreba u marinama
Suitable for use in Marinas

Upotreba u ribogojilištima
Suitable for use in Fish Farms

Upotreba za električni priključak plovila
Boat electrical connection



- Utičnice s poklopcem omogućavaju stupanj zaštite IP44
Sockets with lid provide IP44 degree of protection
- Ugrađena zaštita od preopterećenja - termoprekidač
Built-in overload protection - thermo switch
- Kočnica koja sprječava nekontrolirano odmatanje kabela
Brake mechanism that prevents the cable from accidental unwinding
- Ugrađena zaštita od preopterećenja - termoprekidač
Built-in overload protection - thermo switch
- Svjetlosni indikator napona
Power indicator light
- PVC ručica
PVC handle



Slika / Photo	Šifra / Art. No.	Kabel / Cable	Dužina kabela / Cable length	Boja kabela / Cable color	Utičnice / Sockets	Utičać / Plug	Promjer motalice / Reel diameter	Stupanj zaštite / IP grade	Kom./Kutija / Pcs./ctn	EAN
1	200-398	MarinFlex 3G1,5	25 m	narandžasta / orange	1 x CEE 230 V~ / 16 A 2 x 230 V~ / 16 A	CEE 230 V~ / 16 A	280 mm	IP44	1	3858890449693
2	200-397	MarinFlex 3G1,5	25 m	narandžasta / orange	CEE 230 V~ / 16 A	CEE 230 V~ / 16 A	280 mm	IP44	1	3858890449686

HOBBY LINE

Kabelske motalice

Sam naziv linije sugerira da se radi o proizvodima namijenjenim manje zahtjevnim korisnicima. No, modele iz ove kategorije često ćete naći i u rukama pravih profesionalaca. Visoka kvaliteta ugrađenih komponenti osigurava vrlo dugi radni vijek proizvoda. Pocičani nosač, ugrađeni termoprekidač, utičnice sa zaštitom za djecu, metalni ili PVC bubanj pojačane otpornosti na lomove, samo su neki od detalja koji čine proizvode iz ove kategorije idealnim za svakog korisnika.



Cable Reels

The name of the line itself suggests that these products are made for less demanding users. However, some of the products from this line can often be seen used by professional workers. The high quality of the built-in components guarantees a very long lifespan. Galvanized frame, built-in thermo switch, sockets with Direct contact protection, metal or PVC reel with enhanced resistance to fracture, these are just some of the features that make the products in this category ideal for every user.



- Ugrađena zaštita od preopterećenja - termoprekidač
 Built-in overload protection - thermo switch
- Rotirajuća ergonomska ručica
 Rotating ergonomic handle
- Svjetlosni indikator napona
 Power indicator light
- Metalni bubanj
 Metal reel
- PVC ručica
 PVC handle

AVAILABLE STANDARDS



SCHUKO / TYPE F

FRENCH / TYPE E

BRITISH / TYPE G

Šifra / Art. No.	Kabel / Cable	Dužina kabela / Cable length	Boja kabela / Cable color	Utičnice / Sockets	Utičak / Plug	Promjer motalice / Reel diameter	Stupanj zaštite / IP grade	Kom./kunjija / Pcs/ctn	EAN
0931	H05RR-F 3G2,5	40 m	crna / black	4 x 230 V~ / 16 A	230 V~ / 16 A	280 mm	IP20	1	3859888558847
0929	H05RR-F 3G2,5	25 m	crna / black	4 x 230 V~ / 16 A	230 V~ / 16 A	280 mm	IP20	1	3859888558830
0927	H05RR-F 3G1,5	50 m	crna / black	4 x 230 V~ / 16 A	230 V~ / 16 A	280 mm	IP20	1	3859888558823
0925	H05RR-F 3G1,5	25 m	crna / black	4 x 230 V~ / 16 A	230 V~ / 16 A	280 mm	IP20	1	3859888558816
0911	H05VV-F 3G2,5	40 m	crna / black	4 x 230 V~ / 16 A	230 V~ / 16 A	280 mm	IP20	1	3859888558762
0909	H05VV-F 3G2,5	25 m	crna / black	4 x 230 V~ / 16 A	230 V~ / 16 A	280 mm	IP20	1	3859888558755
0907	H05VV-F 3G1,5	50 m	crna / black	4 x 230 V~ / 16 A	230 V~ / 16 A	280 mm	IP20	1	3859888558748
0905	H05VV-F 3G1,5	25 m	crna / black	4 x 230 V~ / 16 A	230 V~ / 16 A	280 mm	IP20	1	3859888558731



-  Ugrađena zaštita od preopterećenja - termoprekidač
Built-in overload protection - thermo switch
-  Svjetlosni indikator napona
Power indicator light
-  PVC ručkica
PVC handle

AVAILABLE STANDARDS



Šifra / Art. No.	Kabel / Cable	Dužina kabela / Cable length	Boja kabela / Cable color	Utičnice / Sockets	Utičak / Plug	Promjer motalice / Reel diameter	Stupanj zaštite / IP grade	Kom./kutija / Pcs/ctn	EAN
0981	H05RR-F 3G2,5	40 m	crna / black	4 x 230 V~ / 16 A	230 V~ / 16 A	280 mm	IP20	1	3859888558984
0979	H05RR-F 3G2,5	25 m	crna / black	4 x 230 V~ / 16 A	230 V~ / 16 A	280 mm	IP20	1	3859888558977
0977	H05RR-F 3G1,5	50 m	crna / black	4 x 230 V~ / 16 A	230 V~ / 16 A	280 mm	IP20	1	3859888558960
0975	H05RR-F 3G1,5	25 m	crna / black	4 x 230 V~ / 16 A	230 V~ / 16 A	230 mm	IP20	1	3859888558953
0961	H05VV-F 3G2,5	40 m	crna / black	4 x 230 V~ / 16 A	230 V~ / 16 A	280 mm	IP20	1	3859888558946
0959	H05VV-F 3G2,5	25 m	crna / black	4 x 230 V~ / 16 A	230 V~ / 16 A	280 mm	IP20	1	3859888558939

-  Ugrađena zaštita od preopterećenja - termoprekidač
Built-in overload protection - thermo switch

AVAILABLE STANDARDS



Šifra / Art. No.	Kabel / Cable	Dužina kabela / Cable length	Boja kabela / Cable color	Utičnice / Sockets	Utičak / Plug	Promjer motalice / Reel diameter	Stupanj zaštite / IP grade	Kom./kutija / Pcs/ctn	EAN
0957	H05VV-F 3G1,5	50 m	crna / black	4 x 230 V~ / 16 A	230 V~ / 16 A	280 mm	IP20	1	3859888558922
0956	H05VV-F 3G1,5	40 m	crna / black	4 x 230 V~ / 16 A	230 V~ / 16 A	280 mm	IP20	1	3858883839173
0955	H05VV-F 3G1,5	25 m	crna / black	4 x 230 V~ / 16 A	230 V~ / 16 A	230 mm	IP20	1	3859888558915
0960	H05VV-F 3G1,5	20 m	crna / black	4 x 230 V~ / 16 A	230 V~ / 16 A	230 mm	IP20	1	3858883839210
0953C	H05VV-F 3G1,5	15 m	crna / black	4 x 230 V~ / 16 A	230 V~ / 16 A	230 mm	IP20	1	3858883831573



Konstrukcija motalice je prilagođena za upotrebu s vrtnim električnim alatima. Utičnica se nalazi na kraju kabela, stoga nema potrebe za premještanjem motalice za vrijeme obavljanja radova. Crvena boja kabela se koristi radi lakše vidljivosti kako bi se izbjegla oštećenja pri slučajnom kontaktu s električnim alatom u radu.

The construction of the reel is designed for use with garden power tools. The socket is at the end of the cable so there is no need to move around the cable reel during the work. The red color of the cable is used for better visibility in order to avoid damage during accidental contact with the power tools at work.



- Ugrađena zaštita od preopterećenja - termoprekidač**
 Built-in overload protection – thermo switch
- Svjetlosni indikator napona**
 Power indicator light

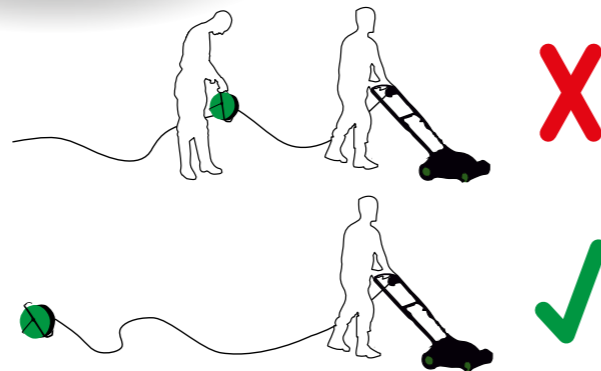

AVAILABLE STANDARDS

SCHUKO / TYPE F

FRENCH / TYPE E

Šifra / Art. No.	Kabel / Cable	Dužina kabela / Cable length	Boja kabela / Cable color	Utičnice / Sockets	Utičnik / Plug	Promjer motalice / Reel diameter	Stupanj zaštite / IP grade	Kom./Kutija / Pcs./Ctn	EAN
0991	H05VV-F 3G1,5	25 m	crvena / red	1 x 230 V~ / 16 A	230 V~ / 16 A	230 mm	IP20	1	3859889306980
0993	H05VV-F 3G1,5	40 m	crvena / red	1 x 230 V~ / 16 A	230 V~ / 16 A	280 mm	IP20	1	3858890442755
0992	H05VV-F 3G1,5	50 m	crvena / red	1 x 230 V~ / 16 A	230 V~ / 16 A	280 mm	IP20	1	3859889306997

Šifra / Art. No.	Kabel / Cable	Dužina kabela / Cable length	Boja kabela / Cable color	Utičnice / Sockets	Utičnik / Plug	Stupanj zaštite / IP grade	Kom./Kutija / Pcs./Ctn	EAN
0890	H05VV-F 3G1	10 m	bijela / white	4 x 230 V~ / 10 A	230 V~ / 16 A	IP20	1	3859889306812

- Ugrađena zaštita od preopterećenja - termoprekidač**
 Built-in overload protection – thermo switch

PRAZNE KABELSKE MOTALICE
EMPTY CABLE REELS

- Ugrađena zaštita od preopterećenja - termoprekidač**
 Built-in overload protection – thermo switch

Šifra / Art. No.	Utičnice / Sockets	Promjer motalice / Reel diameter	Stupanj zaštite / IP grade	Kom./Kutija / Pcs./Ctn	EAN
0998	4 x 230 V~ / 16 A	230 mm	IP20	1	3859888761773
0999	4 x 230 V~ / 16 A	280 mm	IP20	1	3859888761834

Razdjelni ormari

Commel asortiman razdjelnih ormara je potpuno prilagođen za industrijske, građevinske i ostale profi radove i jamči pouzdano i sigurno korištenje električne energije kod teških uvjeta rada.

Mobile Power Stations

Commel's range of mobile power stations is fully adapted for industrial, construction and other professional work and guarantees reliable and safe use of electricity when operating at heavy-duty conditions.

Commel®



 IP zaštita 44.
IP Grade 44.

Sifra / Art. No.	Utikač / Plug	Kabel / Cable	Dužina / Length	Natikač / Outlet socket	Zaštita / Protection	Kom./Kutija / Pcs/ctn	EAN
114-101	1 x CEE 16 A 400 V 5P	H07RN-F 5G2,5	2 m	3 x CEE 16 A 400 V 5P 5 x Schuko 16 A 250 V	1 x RCCB 40 A 4P 0,03 A 2 x MCB 16 A 3P C 2 x MCB 16 A 1P C	1	3856024406734
114-102	1 x CEE 32 A 400 V 5P	H07RN-F 5G4	2 m	2 x CEE 16 A 400 V 5P 1 x CEE 32 A 400 V 5P 5 x Schuko 16 A 250 V	1 x RCCB 40 A 4P 0,03 A 1 x MCB 16 A 3P C 3 x MCB 16 A 1P C	1	3856024406741



Priključni kabeli

Commel priključni kabeli namijenjeni su spajanju svih vrsta električnih aparata na električnu mrežu. Bilo da je riječ o njihovoj ugradnji odmah u tvornici na električni aparat ili da to sami radite kod kuće, bolji i pouzdaniji priključak Vašeg aparata na električnu mrežu niste mogli odabrati! Garancija vrhunske kvalitete je posjedovanje VDE certifikata.

Connection Cables

Commel connection cables are designed for connecting all types of electrical appliances to the power supply. Whether they are already installed in an electrical appliance by producer or you are doing that by yourself at home, you can be sure that you are using the most reliable connection of your appliance to the power supply! The top quality of Commel connection cables has been approved and confirmed by VDE Testing and Certification Institute.



PRIKLJUČNI KABELO S EURO UTIKAČEM CONNECTION CABLES WITH EURO PLUG



Šifra / Art. No.	Kabel / Cable	Dužina / Length	Boja / Color	Utikač / Plug	Max. opterećenje / Max. load	Nazivni napon / Voltage	Kom. /kutija / Pcs/ctn	EAN
0114	H03VVH2-F 2x0,75	2 m	bijela / white	2,5 A / 250 V~	2,5 A	250 V~	20	3859888558199
0115	H03VVH2-F 2x0,75	2 m	crna / black	2,5 A / 250 V~	2,5 A	250 V~	20	3859888558205
272-175	H03VVH2-F 2x0,75	2 m	smeđa / brown	2,5 A / 250 V~	2,5 A	250 V~	20	3856024401968
272-176	H03VVH2-F 2x0,75	2 m	zlatna / gold	2,5 A / 250 V~	2,5 A	250 V~	20	3856024401975
0118	H03VVH2-F 2x0,75	3 m	bijela / white	2,5 A / 250 V~	2,5 A	250 V~	20	3859888558212
0119	H03VVH2-F 2x0,75	3 m	crna / black	2,5 A / 250 V~	2,5 A	250 V~	20	3859888558229

PRIKLJUČNI KABELO S EURO UTIKAČEM I SKLOPKOM CONNECTION CABLES WITH EURO PLUG & SWITCH



Šifra / Art. No.	Kabel / Cable	Dužina / Length	Boja / Color	Utikač / Plug	Max. opterećenje / Max. load	Nazivni napon / Voltage	Kom. /kutija / Pcs/ctn	EAN
0112	H03VVH2-F 2x0,75	2 m	bijela / white	2,5 A / 250 V~	2,5 A	250 V~	20	3859888558427
0113	H03VVH2-F 2x0,75	2 m	crna / black	2,5 A / 250 V~	2,5 A	250 V~	20	3859888558434
0128	H03VVH2-F 2x0,75	2 m	zlatna / gold	2,5 A / 250 V~	2,5 A	250 V~	20	3859889306683
272-185	H03VVH2-F 2x0,75	2 m	smeđa / brown	2,5 A / 250 V~	2,5 A	250 V~	20	3856024401982
0116	H03VVH2-F 2x0,75	3 m	bijela / white	2,5 A / 250 V~	2,5 A	250 V~	20	3859889306287
0117	H03VVH2-F 2x0,75	3 m	crna / black	2,5 A / 250 V~	2,5 A	250 V~	20	3859889306300



Kabeli s tekstilnim plaštem najčešće se koriste za ugradnju u glačala i slične uređaje kod kojih postoji mogućnost kontakta kabela s vrućom površinom.

Cables with textile sheath are most commonly used on electric irons and certain other kinds of appliances which have a high risk of the cable being exposed to very high temperatures, by direct contact with the heating element.



ŠUKO PRIKLJUČNI KABELO S TEKSTILNIM PLAŠTEM
SCHUKO CONNECTION CABLES WITH TEXTILE SHEATH

Šifra / Art. No.	Kabel / Cable	Dužina / Length	Boja / Color	Utikač / Plug	Max. opterećenje / Max. load	Nazivni napon / Voltage	Kom. /kutija / Pcs/ctn	EAN
0333	H03RT-H 3G0,75	2 m	bijela / white	16 A / 250 V~	6 A / 1300 W	250 V~	20	3859888558403
0339	H03RT-H 3G0,75	3 m	bijela / white	16 A / 250 V~	6 A / 1300 W	250 V~	20	3859888558410
272-401	H03RT-H 3G1	2 m	bijela / white	16 A / 250 V~	10 A / 2200 W	250 V~	20	3858890448504
272-402	H03RT-H 3G1	3 m	bijela / white	16 A / 250 V~	10 A / 2200 W	250 V~	20	3858890448511



ŠUKO PRIKLJUČNI KABELO S PVC PLAŠTEM
SCHUKO CONNECTION CABLES WITH PVC SHEATH

Šifra / Art. No.	Kabel / Cable	Dužina / Length	Boja / Color	Utikač / Plug	Max. opterećenje / Max. load	Nazivni napon / Voltage	Kom. /kutija / Pcs/ctn	EAN
0310	H05VV-F 3G0,75	1,5 m	bijela / white	16 A / 250 V~	6 A / 1300 W	250 V~	20	3859888558601
0311	H05VV-F 3G0,75	1,5 m	crna / black	16 A / 250 V~	6 A / 1300 W	250 V~	20	38598889306508
0314	H05VV-F 3G0,75	2 m	bijela / white	16 A / 250 V~	6 A / 1300 W	250 V~	20	3859888558236
0315	H05VV-F 3G0,75	2 m	crna / black	16 A / 250 V~	6 A / 1300 W	250 V~	20	38598889306089
0318	H05VV-F 3G0,75	3 m	bijela / white	16 A / 250 V~	6 A / 1300 W	250 V~	20	3859888558243
0319	H05VV-F 3G0,75	3 m	crna / black	16 A / 250 V~	6 A / 1300 W	250 V~	20	38598889306102
0481	H05VV-F 3G1	1,5 m	bijela / white	16 A / 250 V~	10 A / 2200 W	250 V~	10	3858883833249
0482	H05VV-F 3G1	1,5 m	crna / black	16 A / 250 V~	10 A / 2200 W	250 V~	10	3858883833256
0484	H05VV-F 3G1	2 m	bijela / white	16 A / 250 V~	10 A / 2200 W	250 V~	10	3858883833263
0486	H05VV-F 3G1	2 m	crna / black	16 A / 250 V~	10 A / 2200 W	250 V~	10	3858883833270
0488	H05VV-F 3G1	3 m	bijela / white	16 A / 250 V~	10 A / 2200 W	250 V~	10	3858883833287
0489	H05VV-F 3G1	3 m	crna / black	16 A / 250 V~	10 A / 2200 W	250 V~	10	3858883833294
0512	H05VV-F 3G1,5	1,5 m	bijela / white	16 A / 250 V~	16 A / 3500 W	250 V~	10	3859888558625
0511	H05VV-F 3G1,5	1,5 m	crna / black	16 A / 250 V~	16 A / 3500 W	250 V~	10	3859888558618
0514	H05VV-F 3G1,5	2 m	bijela / white	16 A / 250 V~	16 A / 3500 W	250 V~	10	3859888558250
0515	H05VV-F 3G1,5	2 m	crna / black	16 A / 250 V~	16 A / 3500 W	250 V~	10	3859888558670
0518	H05VV-F 3G1,5	3 m	bijela / white	16 A / 250 V~	16 A / 3500 W	250 V~	10	3859888558267
0519	H05VV-F 3G1,5	3 m	crna / black	16 A / 250 V~	16 A / 3500 W	250 V~	10	3859888558632
0610	H05VV-F 3G2,5	1,5 m	bijela / white	16 A / 250 V~	16 A / 3500 W	250 V~	10	3859888558472
0611	H05VV-F 3G2,5	1,5 m	crna / black	16 A / 250 V~	16 A / 3500 W	250 V~	10	3859888558489
0614	H05VV-F 3G2,5	2 m	bijela / white	16 A / 250 V~	16 A / 3500 W	250 V~	10	3859888558274
0615	H05VV-F 3G2,5	2 m	crna / black	16 A / 250 V~	16 A / 3500 W	250 V~	10	3859888558298
0618	H05VV-F 3G2,5	3 m	bijela / white	16 A / 250 V~	16 A / 3500 W	250 V~	10	3859888558281
0619	H05VV-F 3G2,5	3 m	crna / black	16 A / 250 V~	16 A / 3500 W	250 V~	10	3859888558304



ŠUKO PRIKLJUČNI KABELO S GUMENIM PLAŠTEM
SCHUKO CONNECTION CABLES WITH RUBBER SHEATH

Šifra / Art. No.	Kabel / Cable	Dužina / Length	Boja / Color	Utikač / Plug	Max. opterećenje / Max. load	Nazivni napon / Voltage	Kom. /kutija / Pcs/ctn	EAN
0631	H05RR-F 3G2,5	1,5 m	crna / black	16 A / 250 V~	16 A / 3500 W	250 V~	10	3859888558496
0635	H05RR-F 3G2,5	2 m	crna / black	16 A / 250 V~	16 A / 3500 W	250 V~	10	3859888558311
0639	H05RR-F 3G2,5	3 m	crna / black	16 A / 250 V~	16 A / 3500 W	250 V~	10	3859888558328
272-301	H05RR-F 3G1,5	1,5 m	crna / black	16 A / 250 V~	16 A / 3500 W	250 V~	10	3858890448351
272-302	H05RR-F 3G1,5	2 m	crna / black	16 A / 250 V~	16 A / 3500 W	250 V~	10	3858890448368
272-303	H05RR-F 3G1,5	3 m	crna / black	16 A / 250 V~	16 A / 3500 W	250 V~	10	3858890448375

PRIKLJUČNI KABELO ZA ELEKTRIČNE ALATE
CONNECTION CABLES FOR POWER TOOLS

Priključni kabeli s kontur utikačem se ugrađuju u električne alate s plastičnim kućištem.
Connection cables with contour plug are installed in power tools with plastic housing.



Šifra / Art. No.	Kabel / Cable	Dužina / Length	Boja / Color	Utikač / Plug	Max. opterećenje / Max. load	Nazivni napon / Voltage	Kom. /kutija / Pcs/ctn	EAN
272-501	H05RN-F 2x1	2 m	crna / black	10 A / 250 V~	10 A / 2200 W	250 V~	20	3856024405645
272-502	H05RN-F 2x1	4 m	crna / black	10 A / 250 V~	10 A / 2200 W	250 V~	20	3856024405652
0282	H05RR-F 2x1	4 m	crna / black	10 A / 250 V~	10 A / 2200 W	250 V~	20	3858883830149
0283	H05RR-F 2x1,5	4 m	crna / black	10 A / 250 V~	16 A / 3500 W	250 V~	10	3858883833225
0285	H05VV-F 2x1	3,5 m	crna / black	10 A / 250 V~	10 A / 2200 W	250 V~	20	3859889306362

TROFAZNI PRIKLJUČNI KABELOVI
CONNECTION CABLES WITH THREE-PHASE POWER PLUG

Šifra / Art. No.	Kabel / Cable	Dužina / Length	Boja / Color	Utikač / Plug	Max. opterećenje / Max. load	Nazivni napon / Voltage	Kom. /kutija / Pcs/ctn	EAN
0713	H05VV-F 5G2,5	1,5 m	crna / black	16 / 400 V~	16 A / 10.000 W	400 V~	10	3859888558564
0715	H05VV-F 5G2,5	2 m	crna / black	16 / 400 V~	16 A / 10.000 W	400 V~	10	3859888558335
0719	H05VV-F 5G2,5	3 m	crna / black	16 / 400 V~	16 A / 10.000 W	400 V~	10	3859888558342
0733	H05RR-F 5G2,5	1,5 m	crna / black	16 / 400 V~	16 A / 10.000 W	400 V~	10	3859888558540
0735	H05RR-F 5G2,5	2 m	crna / black	16 / 400 V~	16 A / 10.000 W	400 V~	10	3859888558359
0739	H05RR-F 5G2,5	3 m	crna / black	16 / 400 V~	16 A / 10.000 W	400 V~	10	3859888558366



PRIKLJUČNI KABELOVI ZA STALNI PRIKLJUČAK
CONNECTION CABLES FOR STOVES

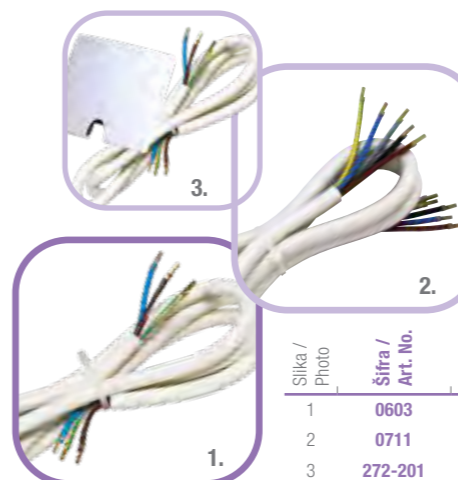

Slika / Photo	Šifra / Art. No.	Kabel / Cable	Dužina / Length	Boja / Color	Max. opterećenje / Max. load	Nazivni napon / Voltage	Kom. /kutija / Pcs/ctn	EAN
1	0603	H05VV-F 3G2,5	1,5 m	bijela / white	5000 W	250 V~	10	3859888558502
2	0711	H05VV-F 5G2,5	1,5 m	bijela / white	12000 W	400 V~	10	3859888558526
3	272-201	H05VV-F 3G2,5	1,5 m	bijela / white	5000 W	250 V~	10	3858883832389

Produžni kabeli

Teški uvjeti na gradilištu, prelazak automobilske gume preko kabela, izloženost kiši ili pak visokim temperaturama neće utjecati na sigurnost korisnika i trajnost proizvoda jer su artikli iz ove kategorije stvoreni upravo za takve uvjete. Prvenstveno su namijenjeni za profesionalnu upotrebu na gradilištima, u industriji i brodogradnji i ali i ostalim korisnicima koji zahtijevaju najvišu razinu pouzdanosti.

Extension Cables

Difficult working conditions on construction sites, crossing over by car, exposure to rain or high temperatures, all of this will not affect the user's safety and durability of these items because they are made for such conditions. They are primarily intended for professional use on construction sites, in industry and shipbuilding, but also for all others who require the highest level of reliability.



Sifra / Art. No.	Kabel / Cable	Dužina / Length	Boja / Color	Max. opterećenje / Max. load	Nazivni napon / Voltage	Stupanj zaštite / IP grade	Kom. /kutija / Pcs/ctn	EAN
221-141	H07BQ-F 5G1,5	5 m	narandžasta / orange	16 A / 10500 W	400 V~	IP44	1	3856024405744
221-142	H07BQ-F 5G1,5	10 m	narandžasta / orange	16 A / 10500 W	400 V~	IP44	1	3856024405751
221-143	H07BQ-F 5G1,5	20 m	narandžasta / orange	16 A / 10500 W	400 V~	IP44	1	3856024405768
221-151	H07BQ-F 5G2,5	5 m	narandžasta / orange	16 A / 10500 W	400 V~	IP44	1	3856024405775
221-152	H07BQ-F 5G2,5	10 m	narandžasta / orange	16 A / 10500 W	400 V~	IP44	1	3856024405782
221-153	H07BQ-F 5G2,5	20 m	narandžasta / orange	16 A / 10500 W	400 V~	IP44	1	3856024405799



Sifra / Art. No.	Kabel / Cable	Dužina / Length	Boja / Color	Max. opterećenje / Max. load	Nazivni napon / Voltage	Stupanj zaštite / IP grade	Kom. /kutija / Pcs/ctn	EAN
221-111	H07RN-F 5G1,5	5 m	crna / black	16 A / 10500 W	400 V~	IP44	1	3858890447897
221-112	H07RN-F 5G1,5	10 m	crna / black	16 A / 10500 W	400 V~	IP44	1	3858890447903
221-113	H07RN-F 5G1,5	20 m	crna / black	16 A / 10500 W	400 V~	IP44	1	3858890447910
221-131	H07RN-F 5G2,5	5 m	crna / black	16 A / 10500 W	400 V~	IP44	1	3858890447682
221-132	H07RN-F 5G2,5	10 m	crna / black	16 A / 10500 W	400 V~	IP44	1	3858890447699
221-133	H07RN-F 5G2,5	20 m	crna / black	16 A / 10500 W	400 V~	IP44	1	3858890448184



Sifra / Art. No.	Kabel / Cable	Dužina / Length	Boja / Color	Max. opterećenje / Max. load	Nazivni napon / Voltage	Stupanj zaštite / IP grade	Kom. /kutija / Pcs/ctn	EAN
221-101	AT N07V3V3-F 5G2,5	5 m	žuta / yellow	16 A / 10500 W	400 V~	IP44	1	3858890447866
221-102	AT N07V3V3-F 5G2,5	10 m	žuta / yellow	16 A / 10500 W	400 V~	IP44	1	3858890447873
221-103	AT N07V3V3-F 5G2,5	20 m	žuta / yellow	16 A / 10500 W	400 V~	IP44	1	3858890447880



Kabeli s utikačem i natikačem CEE 16A 3P prvenstveno su namijenjeni korištenju u kampovima i marinama za priključivanje kamp kućica i brodova na električnu mrežu. Stupanj zaštite IP44 omogućava korištenje na otvorenom i u vlažnim uvjetima.

Extension cables with CEE 16A 3P plug and socket are primarily intended for use at campsites and in marinas for connecting caravans and boats to the power supply. IP 44 degree of protection enables their use outdoors and under humid conditions.



MADE IN EUROPE

Šifra / Art. No.	Kabel / Cable	Dužina / Length	Boja / Color	Max. opterećenje / Max. load	Nazivni napon / Voltage	Stupanj zaštite / IP grade	Kom./kutija / Pcs/ctn	EAN
221-301	H07RN-F 3G1,5	5 m	crna / black	16 A / 3500 W	250 V~	IP44	1	3858890448191
221-302	H07RN-F 3G1,5	10 m	crna / black	16 A / 3500 W	250 V~	IP44	1	3858890448207
221-303	H07RN-F 3G1,5	20 m	crna / black	16 A / 3500 W	250 V~	IP44	1	3858890447927
221-321	H07RN-F 3G2,5	5 m	crna / black	16 A / 3500 W	250 V~	IP44	1	3858890448214
221-322	H07RN-F 3G2,5	10 m	crna / black	16 A / 3500 W	250 V~	IP44	1	3858890448221
221-323	H07RN-F 3G2,5	20 m	crna / black	16 A / 3500 W	250 V~	IP44	1	3858890448238



MADE IN EUROPE

Šifra / Art. No.	Kabel / Cable	Dužina / Length	Boja / Color	Max. opterećenje / Max. load	Nazivni napon / Voltage	Stupanj zaštite / IP grade	Kom./kutija / Pcs/ctn	EAN
0658	H05RR-F 3G1,5	5 m	crna / black	16 A / 3500 W	250 V~	IP44	1	3858883833027
0658B	H05RR-F 3G1,5	25 m	crna / black	16 A / 3500 W	250 V~	IP44	1	3858883833348
220-401	H07RN-F 3G1,5	5 m	crna / black	16 A / 3500 W	250 V~	IP44	1	3858890448245
220-402	H07RN-F 3G1,5	10 m	crna / black	16 A / 3500 W	250 V~	IP44	1	3858890447965
220-403	H07RN-F 3G1,5	20 m	crna / black	16 A / 3500 W	250 V~	IP44	1	3858890447972
220-421	H07RN-F 3G2,5	5 m	crna / black	16 A / 3500 W	250 V~	IP44	1	3858890448252
220-422	H07RN-F 3G2,5	10 m	crna / black	16 A / 3500 W	250 V~	IP44	1	3858890448269
220-423	H07RN-F 3G2,5	20 m	crna / black	16 A / 3500 W	250 V~	IP44	1	3858890448276



MADE IN EUROPE

Šifra / Art. No.	Kabel / Cable	Dužina / Length	Boja / Color	Max. opterećenje / Max. load	Nazivni napon / Voltage	Stupanj zaštite / IP grade	Kom./kutija / Pcs/ctn	EAN
221-311	AT N07V3V3-F 3G1,5	5 m	žuta / yellow	16 A / 3500 W	250 V~	IP44	1	3858890447934
221-312	AT N07V3V3-F 3G1,5	10 m	žuta / yellow	16 A / 3500 W	250 V~	IP44	1	3858890447941
221-313	AT N07V3V3-F 3G1,5	20 m	žuta / yellow	16 A / 3500 W	250 V~	IP44	1	3858890447958



MADE IN EUROPE

Šifra / Art. No.	Kabel / Cable	Dužina / Length	Boja / Color	Max. opterećenje / Max. load	Nazivni napon / Voltage	Stupanj zaštite / IP grade	Kom./kutija / Pcs/ctn	EAN
220-411	AT N07V3V3-F 3G1,5	5 m	žuta / yellow	16 A / 3500 W	250 V~	IP44	1	3858890447989
220-412	AT N07V3V3-F 3G1,5	10 m	žuta / yellow	16 A / 3500 W	250 V~	IP44	1	3858890447996
220-413	AT N07V3V3-F 3G1,5	20 m	žuta / yellow	16 A / 3500 W	250 V~	IP44	1	3858890448009



H07BQ-F – izvrsna otpornost na mehanička opterećenja, habanje, vremenske prilike, vodu, ulja i masti. Visoka fleksibilnost pri temperaturama do -40°C. Mogućnost upotrebe na visokim temperaturama okoline do +90°C.

H07BQ-F – excellent resistance to mechanical and tear stress, weather conditions, water, oils and greases. High flexibility at temperatures low as -40°C. Can be used at high ambient temperatures up to +90°C.



AVAILABLE STANDARDS



Šifra / Art. No.	Kabel / Cable	Dužina / Length	Boja / Color	Max. opterećenje / Max. load	Nazivni napon / Voltage	Stupanj zaštite / IP grade	Kom./kutija / Pcs/ctn	EAN
220-321	H07BQ-F 3G1,5	5 m	narančasta / orange	16 A / 3500 W	250 V~	IP44	1	3856024405683
220-322	H07BQ-F 3G1,5	10 m	narančasta / orange	16 A / 3500 W	250 V~	IP44	1	3856024405690
220-323	H07BQ-F 3G1,5	20 m	narančasta / orange	16 A / 3500 W	250 V~	IP44	1	3856024405706
220-331	H07BQ-F 3G2,5	5 m	narančasta / orange	16 A / 3500 W	250 V~	IP54	1	3856024405713
220-332	H07BQ-F 3G2,5	10 m	narančasta / orange	16 A / 3500 W	250 V~	IP54	1	3856024405720
220-333	H07BQ-F 3G2,5	20 m	narančasta / orange	16 A / 3500 W	250 V~	IP54	1	3856024405737



H07RN-F – ova oznaka označava gumeni kabel ali za razliku od **H05RR-F** kabela ima izraženu otpornost na mehanička oštećenja. Naravno, veća fleksibilnost u odnosu na PVC kabel je zadržana.

H07RN-F - this mark indicates a rubber cable, but unlike a **H05RR-F** cable, it has a strong resistance to mechanical damage and, of course, greater flexibility compared to a PVC cable.



AVAILABLE STANDARDS

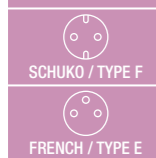

Šifra / Art. No.	Kabel / Cable	Dužina / Length	Boja / Color	Max. opterećenje / Max. load	Nazivni napon / Voltage	Stupanj zaštite / IP grade	Kom./kutija / Pcs/ctn	EAN
220-301	H07RN-F 3G1,5	5 m	crna / black	16 A / 3500 W	250 V~	IP44	1	3858890448016
220-302	H07RN-F 3G1,5	10 m	crna / black	16 A / 3500 W	250 V~	IP44	1	3858890448023
220-303	H07RN-F 3G1,5	20 m	crna / black	16 A / 3500 W	250 V~	IP44	1	3858890448030
220-311	H07RN-F 3G2,5	5 m	crna / black	16 A / 3500 W	250 V~	IP54	1	3858890448047
220-312	H07RN-F 3G2,5	10 m	crna / black	16 A / 3500 W	250 V~	IP54	1	3858890448054
220-313	H07RN-F 3G2,5	20 m	crna / black	16 A / 3500 W	250 V~	IP54	1	3858890448061



AT N07V3V3-F produžni kabeli namijenjeni su za otežane uvjete korištenja kao što su na gradilištima, u industriji, brodogradnji i sl. Prednost **AT N07V3V3-F** kabela u odnosu na standardne PVC kabele je pojačana otpornost na mehanička oštećenja, vodu, ulja, kemikalije te fleksibilnost do -35 °C. Prednost u odnosu na gumene kabele je niža cijena finalnog proizvoda.

AT N07V3V3-F connection cables are designed for operating at heavy-duty conditions such as those on construction sites, in industry, shipbuilding, etc. The advantage of **AT N07V3V3-F** cables over standard PVC cables is enhanced resistance to mechanical damage, water, oil, chemicals and greater flexibility - up to -35 °C. The advantage of **AT N07V3V3-F** cables over rubber cables is lower price of a final product.



AVAILABLE STANDARDS



Šifra / Art. No.	Kabel / Cable	Dužina / Length	Boja / Color	Max. opterećenje / Max. load	Nazivni napon / Voltage	Stupanj zaštite / IP grade	Kom./kutija / Pcs/ctn	EAN
220-701	AT N07V3V3-F 3G1,5	5 m	žuta / yellow	16 A / 3500 W	250 V~	IP44	1	3858890448078
220-702	AT N07V3V3-F 3G1,5	10 m	žuta / yellow	16 A / 3500 W	250 V~	IP44	1	3858890448085
220-704	AT N07V3V3-F 3G1,5	20 m	žuta / yellow	16 A / 3500 W	250 V~	IP44	1	3858890444575
220-761	AT N07V3V3-F 3G2,5	5 m	žuta / yellow	16 A / 3500 W	250 V~	IP54	1	3858890448092
220-762	AT N07V3V3-F 3G2,5	10 m	žuta / yellow	16 A / 3500 W	250 V~	IP54	1	3858890448108
220-764	AT N07V3V3-F 3G2,5	20 m	žuta / yellow	16 A / 3500 W	250 V~	IP54	1	3858890444605



Šifra / Art. No.	Kabel / Cable	Dužina / Length	Boja / Color	Max. opterećenje / Max. load	Nazivni napon / Voltage	Stupanj zaštite / IP grade	Kom./kutija / Pcs/ctn	EAN
221-901	H07RN-F 5G2,5	1.5 m	crna / black	16 A / 9500 W	400 V~	IP44	1	3858890448115

ADAPTER ZA PRETVARANJE CEE STANDARDA U ŠUKO STANDARD.
PLUG ADAPTER FOR CONVERTING CEE TO SCHUKO STANDARD.



AVAILABLE STANDARDS	SCHUKO / TYPE F	FRENCH / TYPE E
	<input checked="" type="checkbox"/>	<input type="checkbox"/>

Šifra / Art. No.	Kabel / Cable	Dužina / Length	Boja / Color	Max. opterećenje / Max. load	Nazivni napon / Voltage	Stupanj zaštite / IP grade	Kom./kutija / Pcs/ctn	EAN
221-212	H07RN-F 3G1,5	1.5 m	crna / black	16 A / 3500 W	250 V~	IP44	10	3858890448290

ADAPTER ZA PRETVARANJE ŠUKO STANDARDA U CEE STANDARD.
PLUG ADAPTER FOR CONVERTING SCHUKO TO CEE STANDARD.



Šifra / Art. No.	Kabel / Cable	Dužina / Length	Boja / Color	Max. opterećenje / Max. load	Nazivni napon / Voltage	Stupanj zaštite / IP grade	Kom./kutija / Pcs/ctn	EAN
221-202	H07RN-F 3G1,5	1.5	crna / black	16 A / 3500 W	250 V~	IP44	10	3858890448283

SIGURNOSNI PRODUŽNI KABEL SA STRUJNOM ZAŠTITNOM SKLOPKOM
SAFETY EXTENSION CABLE WITH RCD SWITCH



AVAILABLE STANDARDS	SCHUKO / TYPE F	FRENCH / TYPE E
	<input checked="" type="checkbox"/>	<input type="checkbox"/>

Zaštita od ponovnog uključivanja nakon nestanka struje.
With anti-restart protection after a power interruption occurs.

Šifra / Art. No.	Kabel / Cable	Dužina / Length	Boja / Color	Max. opterećenje / Max. load	Nazivni napon / Voltage	Stupanj zaštite / IP grade	Kom./kutija / Pcs/ctn	Diferencijalna struja / Tripping current	EAN
222-201	H07RN-F 3G1,5	1.5 m	crna / black	16 A	250 V~	IP20	1	30 mA	3858890448122

SIGURNOSNI PRODUŽNI KABEL SA STRUJNOM ZAŠTITNOM SKLOPKOM
SAFETY EXTENSION CABLE WITH RCD SWITCH



AVAILABLE STANDARDS	SCHUKO / TYPE F	FRENCH / TYPE E
	<input checked="" type="checkbox"/>	<input type="checkbox"/>

Zaštita od ponovnog uključivanja nakon nestanka struje.
With anti-restart protection after a power interruption occurs.

Šifra / Art. No.	Kabel / Cable	Dužina / Length	Boja / Color	Max. opterećenje / Max. load	Nazivni napon / Voltage	Stupanj zaštite / IP grade	Kom./kutija / Pcs/ctn	Diferencijalna struja / Tripping current	EAN
222-101	H07RN-F 3G1,5	1.5 m	crna / black	16 A	250 V~	IP20	1	30 mA	3858890448139



Commel MARINKO grupa proizvoda je opremljena specijalnim MarinFlex kablom otpornim na abrazivna djelovanja morske vode. MarinFlex kabl moguće je koristiti u uvjetima trajnog ili povremenog kontakta s morskom vodom, a odlikuju ga izvrsna fleksibilnost i otpornost na visoke i niske temperature. Posebno je pogodan za električni priključak plovila u marinama jer je jednostavan za održavanje, lako se čisti i ne ostavlja tragove na površinama.

The Commel MARINKO product group is equipped with a special MarinFlex cable resistant to the abrasive action of sea water. The MarinFlex cable can be used in conditions of permanent or occasional contact with sea water, and it has excellent flexibility and resistance to high and low temperatures. It is especially suitable for the electrical connection of boats in the marinas because it is easy to maintain, easy to clean and leaves no traces on the surfaces.



Upotreba u marinama
Suitable for use in Marinas



Upotreba u ribogojilištima
Suitable for use in Fish Farms



Upotreba za električni priključak plovila
Boat electrical connection

Šifra / Art. No.	Kabel / Cable	Dužina kabela / Cable length	Boja kabela / Cable color	Max. opterećenje / Max. load	Nazivni napon / Voltage	Stupanj zaštite / IP grade	Kom./kutija / Pcs/ctn	EAN
221-331	MarinFlex 3G1,5	5 m	narančasta / orange	16 A / 3500 W	250 V~	IP44	1	3858890449631
221-332	MarinFlex 3G1,5	10 m	narančasta / orange	16 A / 3500 W	250 V~	IP44	1	3858890449648
221-333	MarinFlex 3G1,5	20 m	narančasta / orange	16 A / 3500 W	250 V~	IP44	1	3858890449655



Adapter za pretvaranje CEE standarda u šuko standard.
Plug adapter for converting CEE to Schuko standard.

Šifra / Art. No.	Kabel / Cable	Dužina kabela / Cable length	Boja kabela / Cable color	Max. opterećenje / Max. load	Nazivni napon / Voltage	Stupanj zaštite / IP grade	Kom./kutija / Pcs/ctn	EAN
221-213	MarinFlex 3G1,5	1,5 m	narančasta / orange	16 A / 3500 W	250 V~	IP44	1	3858890449679



Adapter za pretvaranje šuko standarda u CEE standard.
Plug adapter for converting Schuko to CEE standard.

Šifra / Art. No.	Kabel / Cable	Dužina kabela / Cable length	Boja kabela / Cable color	Max. opterećenje / Max. load	Nazivni napon / Voltage	Stupanj zaštite / IP grade	Kom./kutija / Pcs/ctn	EAN
221-203	MarinFlex 3G1,5	1,5 m	narančasta / orange	16 A / 3500 W	250 V~	IP44	1	3858890449662

HOBBY LINE

Produžni kabeli

Kada Vam priključak na električnu energiju nije nadohvat ruke, posegnite za Commel produžnim kabelom i dovedite električnu energiju do svih Vaših potrošača. Različite dužine, presjeci i boje kabela pokrivaju sva područja primjene u Vašem domu ili radionici.

Commel®

Extension Cables

When the power supply is not close at hand, reach for the Commel extension cable and bring the power to your appliances. Different lengths, cross sections and cable colors cover all areas of application in your home or workshop.



HOBBY LINE



MADE IN EUROPE



PRODUŽNI KABELI | EXTENSION CABLES

Šifra / Art. No.	Kabel / Cable	Dužina / Length	Boja / Color	Max. opterećenje / Max. load	Nazivni napon / Voltage	Stupanj zaštite / IP grade	Kom. /kutija / Pcs/ctn	EAN
221-121	H05VV-F 5G1,5	5 m	crna / black	16 A / 10500 W	400 V~	IP44	1	3858890448146
0744	H05VV-F 5G1,5	10 m	crna / black	16 A / 10500 W	400 V~	IP44	1	3858883834277
221-123	H05VV-F 5G1,5	20 m	crna / black	16 A / 10500 W	400 V~	IP44	1	3858890448153



H05RR-F – oznaka označava gumeni kabel. Glavna prednost u odnosu na PVC kabel je puno veća fleksibilnost, pogotovo na temperaturama ispod 0°C.

H05RR-F - mark for a rubber cable. Its main advantage over a PVC cable is much greater flexibility, especially at temperatures below 0°C.

MADE IN EUROPE



AVAILABLE STANDARDS
 SCHUKO / TYPE F
 FRENCH / TYPE E

Šifra / Art. No.	Kabel / Cable	Dužina / Length	Boja / Color	Max. opterećenje / Max. load	Nazivni napon / Voltage	Stupanj zaštite / IP grade	Kom. /kutija / Pcs/ctn	EAN
0644	H05RR-F 3G1,5	5 m	crna / black	16 A / 3500 W	250 V~	IP44	1	3858883831672
0645	H05RR-F 3G1,5	10 m	crna / black	16 A / 3500 W	250 V~	IP44	1	3858883831696
0647	H05RR-F 3G1,5	20 m	crna / black	16 A / 3500 W	250 V~	IP44	1	3858883831733
0650	H05RR-F 3G2,5	5 m	crna / black	16 A / 3500 W	250 V~	IP44	1	3859888761728
0651	H05RR-F 3G2,5	10 m	crna / black	16 A / 3500 W	250 V~	IP44	1	3859888761742
0652	H05RR-F 3G2,5	20 m	crna / black	16 A / 3500 W	250 V~	IP44	1	3859888761766



AVAILABLE STANDARDS	SCHUKO / TYPE F	FRENCH / TYPE E	BRITISH / TYPE G
---------------------	-----------------	-----------------	------------------

Šifra / Art. No.	Kabel / Cable	Dužina / Length	Boja / Color	Max. opterećenje / Max. load	Nazivni napon / Voltage	Stupanj zaštite / IP grade	Kom./kutija / Pcs/ctn	EAN
220-110	H05VV-F 3G1	10 m	crvena / red	10 A / 2200 W	250 V~	IP20	1	3858890448160
220-115	H05VV-F 3G1	15 m	crvena / red	10 A / 2200 W	250 V~	IP20	1	3858883836080
0872A	H05VV-F 3G1	20 m	crvena / red	10 A / 2200 W	250 V~	IP20	1	3858883830637
0872	H05VV-F 3G1	25 m	crvena / red	10 A / 2200 W	250 V~	IP20	1	3858883830248
220-205	H05VV-F 3G1,5	5 m	crvena / red	16 A / 3500 W	250 V~	IP20	1	3858890449778
220-210	H05VV-F 3G1,5	10 m	crvena / red	16 A / 3500 W	250 V~	IP20	1	3858890449785
220-215	H05VV-F 3G1,5	15 m	crvena / red	16 A / 3500 W	250 V~	IP20	1	3858890440713
220-220	H05VV-F 3G1,5	20 m	crvena / red	16 A / 3500 W	250 V~	IP20	1	3858890440720
0871	H05VV-F 3G1,5	25 m	crvena / red	16 A / 3500 W	250 V~	IP20	1	3858883830224
220-230	H05VV-F 3G1,5	30 m	crvena / red	16 A / 3500 W	250 V~	IP20	1	3858890449792
220-151	H05VV-F 3G2,5	5 m	crna / black	16 A / 3500 W	250 V~	IP20	1	3858890449402
220-152	H05VV-F 3G2,5	10 m	crna / black	16 A / 3500 W	250 V~	IP20	1	3858890449419
220-153	H05VV-F 3G2,5	20 m	crna / black	16 A / 3500 W	250 V~	IP20	1	3858890449426
220-171	H05RR-F 3G1,5	5 m	crna / black	16 A / 3500 W	250 V~	IP20	1	3858890449464
220-172	H05RR-F 3G1,5	10 m	crna / black	16 A / 3500 W	250 V~	IP20	1	3858890449471
220-173	H05RR-F 3G1,5	20 m	crna / black	16 A / 3500 W	250 V~	IP20	1	3858890449488
220-181	H05RR-F 3G2,5	5 m	crna / black	16 A / 3500 W	250 V~	IP20	1	3858890449433
220-182	H05RR-F 3G2,5	10 m	crna / black	16 A / 3500 W	250 V~	IP20	1	3858890449440
220-183	H05RR-F 3G2,5	20 m	crna / black	16 A / 3500 W	250 V~	IP20	1	3858890449457



Šifra / Art. No.	Kabel / Cable	Dužina / Length	Boja / Color	Max. opterećenje / Max. load	Nazivni napon / Voltage	Stupanj zaštite / IP grade	Kom./kutija / Pcs/ctn	EAN
220-522	H05VV-F 3G1	2 m	crna / black	16 A / 3500 W	250 V~	IP20	10	3856024406413
220-524	H05VV-F 3G1,5	4 m	crna / black	16 A / 3500 W	250 V~	IP20	10	3856024406420
220-528	H05VV-F 3G1,5	8 m	crna / black	16 A / 3500 W	250 V~	IP20	10	3856024406437



Šifra / Art. No.	Kabel / Cable	Dužina / Length	Boja / Color	Max. opterećenje / Max. load	Nazivni napon / Voltage	Stupanj zaštite / IP grade	Kom./kutija / Pcs/ctn	EAN
223-101	H03VWH2-F 2x0,75	2 m	bijela / white	2,5 A / 500 W	250 V~	IP20	20	3858890445985
223-102	H03VWH2-F 2x0,75	4 m	bijela / white	2,5 A / 500 W	250 V~	IP20	20	3858890448177

Bijeli produžni kabeli s PVC plaštom namijenjeni su kućnoj upotrebi. Maksimalno opterećenje od 16 A omogućava priključivanje aparata snage do 3500 W. Utičnice su opremljene zaštitom od kontakta (Zaštita od direktnog kontakta).

White connection cables with PVC sheath are intended for home use. The maximum load of 16 A allows you to manage appliances with power up to 3500 W. The sockets are equipped with contact protection (Direct contact protection).

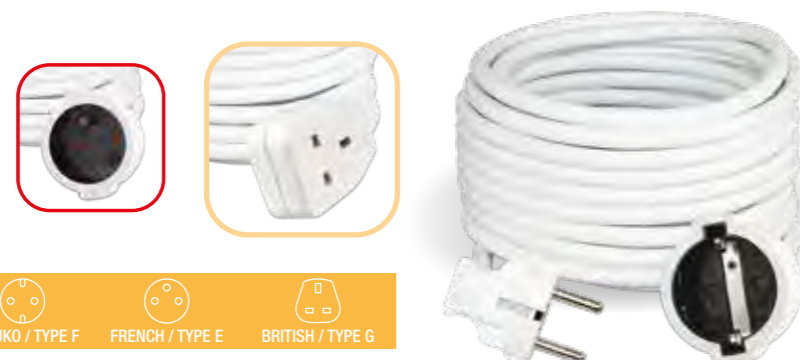

AVAILABLE STANDARDS	SCHUKO / TYPE F	FRENCH / TYPE E	BRITISH / TYPE G
---------------------	-----------------	-----------------	------------------

Šifra / Art. No.	Kabel / Cable	Dužina / Length	Boja / Color	Max. opterećenje / Max. load	Nazivni napon / Voltage	Stupanj zaštite / IP grade	Kom./kutija / Pcs/ctn	EAN
220-502	H05VV-F 3G1	2 m	bijela / white	16 A / 3500 W	250 V~	IP20	10	3858890442861
220-504	H05VV-F 3G1,5	4 m	bijela / white	16 A / 3500 W	250 V~	IP20	10	3858890442878
220-508	H05VV-F 3G1,5	8 m	bijela / white	16 A / 3500 W	250 V~	IP20	10	3858890442885

ZAŠTITNA KUTIJA ZA SPAJANJE KABELA
SAFE BOX FOR CABLE CONNECTION

Šifra / Art. No.	Stupanj zaštite / IP grade	EAN
366-101	IP44	3858890441703



omogućava vodootporni spoj, sprječava razdvajanje utikača od utičnice, mogućnost montaže na zid, 5 kopči za sigurno zatvaranje
allows a waterproof connection, prevents unplugging, possibility of mounting on the wall, 5 clips for safe closing

DRŽAČ KABELA
CABLE HOLDER

Šifra / Art. No.	Maksimalna nosivost / Max. load	Materijal / Material	EAN
366-105	40 kg	LDPE	3858890449624



Prenaponska zaštita

Kada obična prenosiva utičnica ne zadovoljava Vaše sigurnosne standarde i želite dodatno zaštititi svoje električne uređaje preporučujemo upotrebu prenosivih utičnica s prenaponskom zaštitom. Mislite li da je pametno kupiti TV, PC ili neki drugi skupi aparat, a ne kupiti prenaponsku zaštitu za mali djelić vrijednosti tih aparata? Odluka je na Vama ali svaki put za grmljavinskog nevremena razmišljati ćete o mogućoj šteti od udara groma u Vašu električnu mrežu. Prenaponska zaštita ima funkciju preuzeti energiju udara groma i prekinuti strujni krug prema Vašim električnim aparatima.

Surge Protection

When the standard socket outlet does not meet your safety standards and you want to protect further your electrical appliances, we recommend the use of socket outlets with surge protection. Do you think it is wise to buy a TV, PC or other expensive appliance and not buy surge protection for a small fraction of the value of these appliances? It is up to you, but each time during thunderstorms you will be thinking about the possible damage the lightning strike can cause to your appliances. Surge protection is designed to protect appliances against electrical surges and spikes, including those caused by lightning. It attempts to limit the voltage supplied to an appliance by either blocking or shorting to ground any unwanted voltages above a safe threshold.

Commel®



- Zaštita od preopterećenja (termostreživač) – prekida strujni krug u slučaju pregrijavanja utičnice uzrokovano priključivanjem aparata ukupne snage veće od 3500 W**
Overload protection (thermo switch) – cuts off electric current in case of overheating of the socket outlet caused by plugging in appliances with total power greater than 3500 W
- Zaštita od prenapona – štiti priključene uređaje od prenapona uzrokovano udarom groma u električnu mrežu**
Surge protection - protects the appliances against electrical surges and spikes, including those caused by lightning

- 8 šuko utičnice + 2 USB punjača**
8 Schuko sockets + 2 USB chargers



Šifra / Art. No.	Kabel / Cable	Dužina / Length	Broj utičnica / Number of sockets	Max. opterećenje / Max. load	Nazivni napon / Voltage	USB	Kom./kutija / Pcs/ctn	EAN
380-107	H05VV-F 3G1,5	3 m	8 x 230 V ~ / 16 A	16 A / 3500 W	250 V~	5V DC 2,1 A	10	3856024403757

- Zaštita od prenapona – štiti priključene uređaje od prenapona uzrokovano udarom groma u električnu mrežu**
Surge protection - protects the appliances against electrical surges and spikes, including those caused by lightning



Šifra / Art. No.	Kabel / Cable	Dužina / Length	Broj utičnica / Number of sockets	Max. opterećenje / Max. load	Nazivni napon / Voltage	Kom./kutija / Pcs/ctn	EAN
380-105	H05VV-F 3G1,5	1,5 m	6 x 230 V ~ / 16 A	16 A / 3500 W	250 V~	40	3858883838800

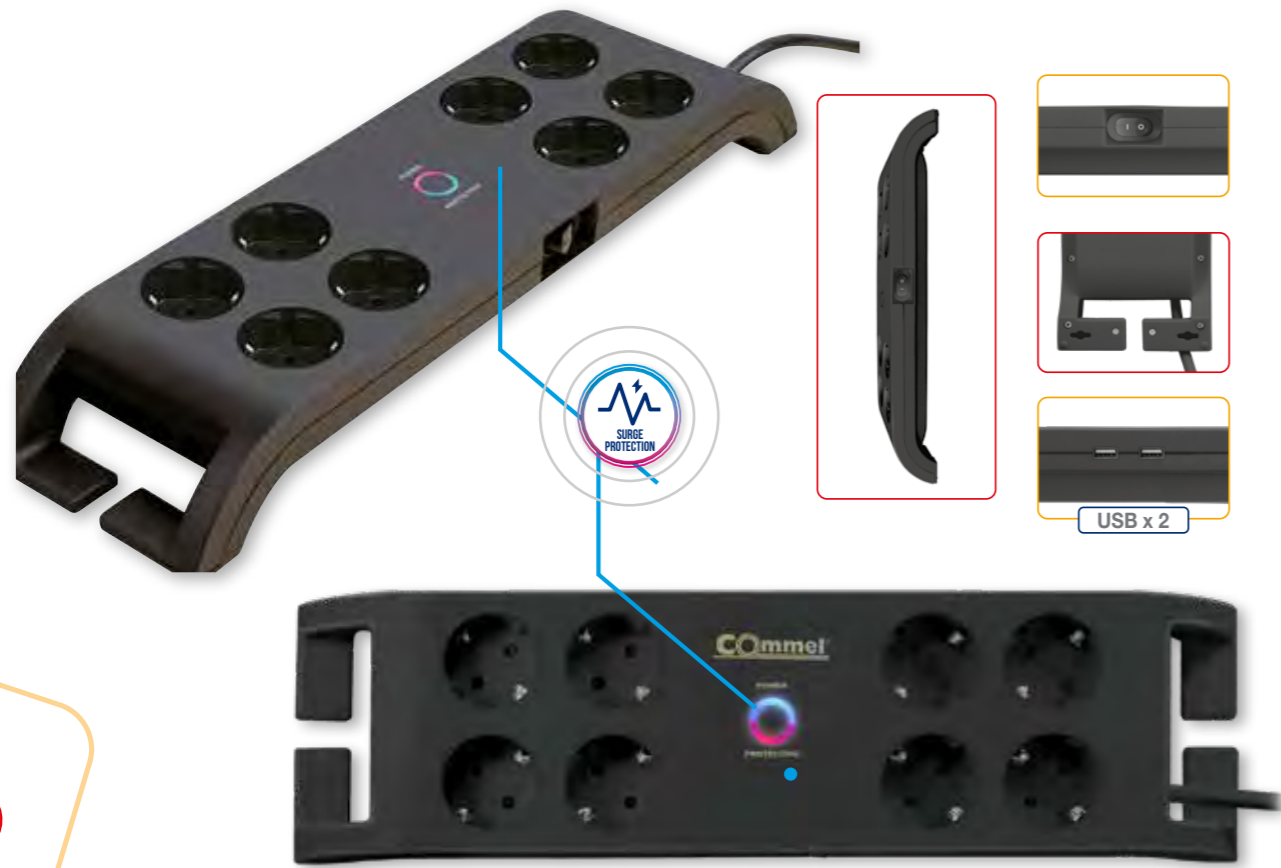

Zaštita od prenapona – štiti priključene uređaje od prenapona uzrokovanog udarom groma u električnu mrežu
 Surge protection - protects the appliances against electrical surges and spikes, including those caused by lightning

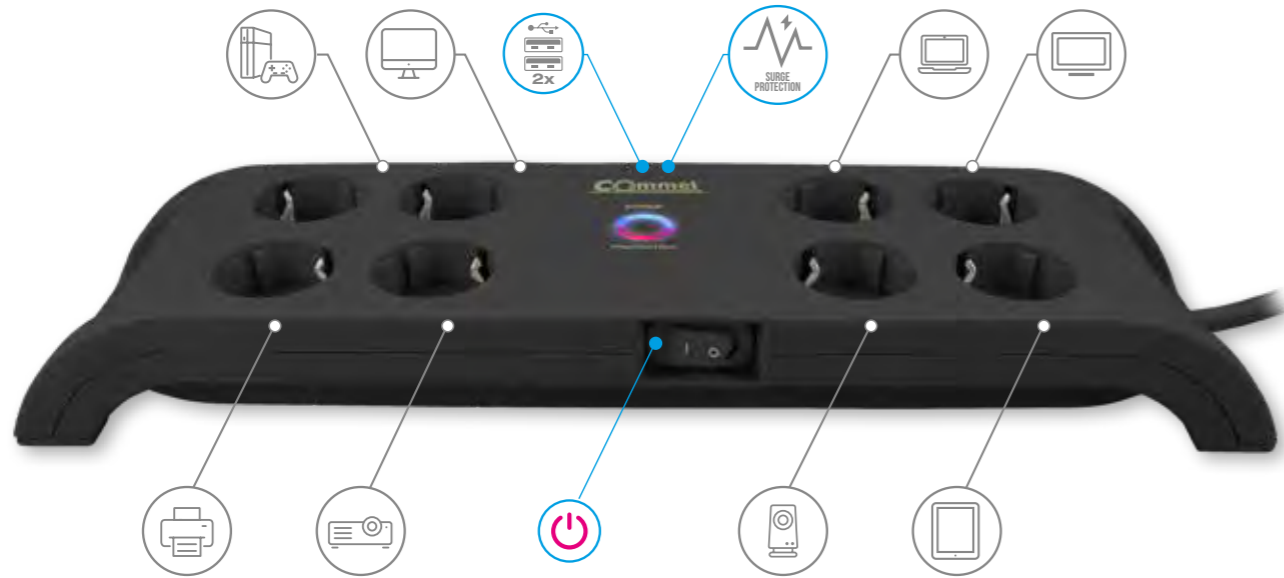

Šifra / Art. No.	Kabel / Cable	Dužina / Length	Boja / Color	Broj utičnica / Number of sockets	Max. opterećenje / Max. load	Nazivni napon / Voltage	USB	Kom./kutija / Pcs./ctn	EAN
380-110	H05VV-F 3G1,5	2 m	crna / black	8 x 250 V ~ / 16 A	16 A / 3680 W	250 V~	2 x 5V DC 2,1 A	10	3856024405973

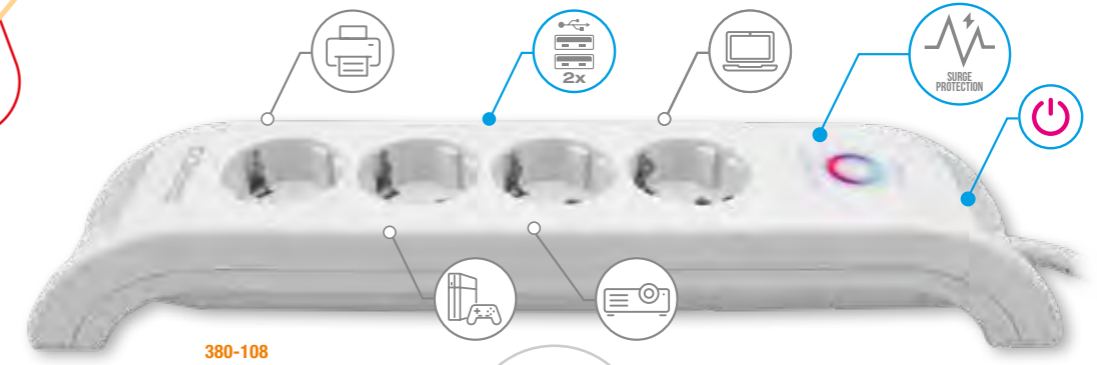

380-108

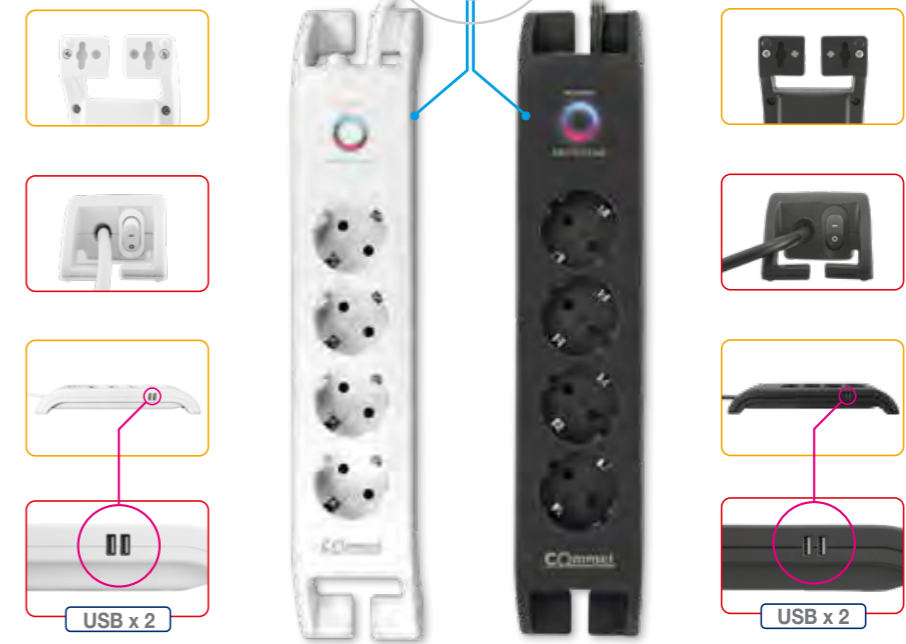

Zaštita od prenapona – štiti priključene uređaje od prenapona uzrokovanog udarom groma u električnu mrežu
 Surge protection - protects the appliances against electrical surges and spikes, including those caused by lightning

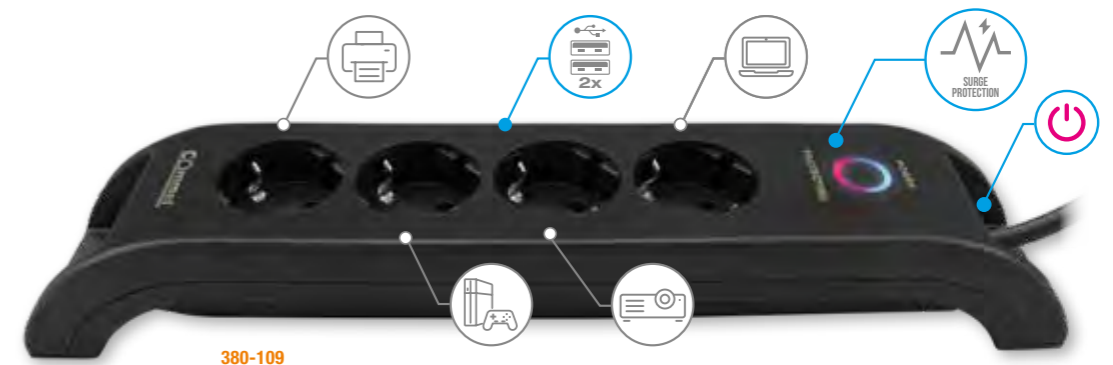

380-109

Šifra / Art. No.	Kabel / Cable	Dužina / Length	Boja / Color	Broj utičnica / Number of sockets	Max. opterećenje / Max. load	Nazivni napon / Voltage	USB	Kom./kutija / Pcs./ctn	EAN
380-108	H05VV-F 3G1,5	2 m	bijela / white	4 x 230 V ~ / 16 A	16 A / 3680 W	250 V~	2 x 5V DC 2,1 A	10	3856024405959
380-109	H05VV-F 3G1,5	2 m	crna / black	4 x 230 V ~ / 16 A	16 A / 3680 W	250 V~	2 x 5V DC 2,1 A	10	3856024405966

Prenosive utičnice

Konstrukcijom i odabirom samogasivih materijala zajamčena je sigurnost pri korištenju. Dvopolna osvjetljena sklopka odvaja na siguran način trošila od mreže. Sve utičnice su opremljene zaštitom od direktnog dodira (Zaštita od direktnog kontakta).

Extension Sockets

The construction and self-extinguishing materials guarantee the safety of use. The two-pole illuminated switch safely disconnects appliances from the power supply. All sockets are equipped with contact protection (Direct contact protection).

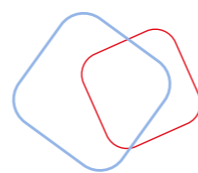

Šifra / Art. No.	Kabel / Cable	Dužina / Length	Broj utičnica / Number of sockets	Max. opterećenje / Max. load	Nazivni napon / Voltage	Kom. /kutija / Pcs/ctn	EAN
0802	H05VV-F 3G1	1,4 m	3	16 A / 3500 W	250 V~	10	3859888558014
0804	H05VV-F 3G1,5	3 m	3	16 A / 3500 W	250 V~	10	3859888558021
0806	H05VV-F 3G1,5	5 m	3	16 A / 3500 W	250 V~	10	3859888558038
0808	H05VV-F 3G1,5	10 m	3	16 A / 3500 W	250 V~	10	3859888558045
232-501	H05VV-F 3G1	1,4 m	5	16 A / 3500 W	250 V~	10	3858883835809
232-502	H05VV-F 3G1,5	3 m	5	16 A / 3500 W	250 V~	10	3858883835465
232-503	H05VV-F 3G1,5	5 m	5	16 A / 3500 W	250 V~	10	3858883835472

 **Zaštita od direktnog kontakta**
Direct contact protection

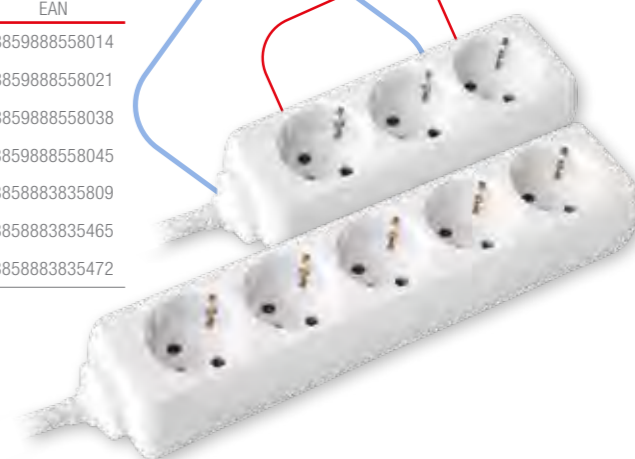

Šifra / Art. No.	Kabel / Cable	Dužina / Length	Broj utičnica / Number of sockets	Max. opterećenje / Max. load	Nazivni napon / Voltage	Kom. /kutija / Pcs/ctn	EAN
0814	H05VV-F 3G1	1,4 m	3	16 A / 3500 W	250 V~	10	3859889306546
0815	H05VV-F 3G1,5	3 m	3	16 A / 3500 W	250 V~	10	3858883830415
0816	H05VV-F 3G1,5	5 m	3	16 A / 3500 W	250 V~	10	3859889306560
0817	H05VV-F 3G1	1,4 m	5	16 A / 3500 W	250 V~	10	3859889306522
232-504	H05VV-F 3G1,5	3 m	5	16 A / 3500 W	250 V~	10	3858883836127
232-505	H05VV-F 3G1,5	5 m	5	16 A / 3500 W	250 V~	10	3858883836134
0838	H05VV-F 3G1	1,4 m	6	16 A / 3500 W	250 V~	10	3859889306607
0837	H05VV-F 3G1,5	3 m	6	16 A / 3500 W	250 V~	10	3858883830439
0839	H05VV-F 3G1,5	5 m	6	16 A / 3500 W	250 V~	10	3859889306584

 **Dvopolna sklopka**
Two-pole illuminated switch

 **Zaštita od direktnog kontakta**
Direct contact protection



Šifra / Art. No.	Kabel / Cable	Dužina / Length	Broj utičnica / Number of sockets	Max. opterećenje / Max. load	Nazivni napon / Voltage	Kom. /kutija / Pcs/ctn	EAN
0843	H05VV-F 3G1	1,4 m	4 x EURO 4 x ŠUKO / SCHUKO	2,5 A / 16 A	250 V~	10	3859889306621

 **Dvopolna sklopka**
Two-pole illuminated switch

 **Zaštita od direktnog kontakta**
Direct contact protection



 **Zaštita od direktnog kontakta**
Direct contact protection





Šifra / Art. No.	Kabel / Cable	Dužina / Length	Broj utičnica / Number of sockets	Max. opterećenje / Max. load	Nazivni napon / Voltage	Kom./kutija / Pcs./ctn	EAN
232-321	H05VV-F 3G1	1,4 m	3	16 A / 3500 W	250 V~	10	3858890446913
232-322	H05VV-F 3G1,5	3 m	3	16 A / 3500 W	250 V~	10	3858890446920
232-323	H05VV-F 3G1,5	5 m	3	16 A / 3500 W	250 V~	10	3856024406161
232-521	H05VV-F 3G1	1,4 m	5	16 A / 3500 W	250 V~	10	3858890447507
232-522	H05VV-F 3G1,5	3 m	5	16 A / 3500 W	250 V~	10	3858890447514
232-523	H05VV-F 3G1,5	5 m	5	16 A / 3500 W	250 V~	10	3856024406185

 **Svjetlosni indikator napona**
Power indicator light

 **3 šuko utičnice + 2 USB punjača**
3 Schuko sockets + 2 USB chargers

Šifra / Art. No.	Boja / Color	Kabel / Cable	Dužina / Length	Broj utičnica / Number of sockets	USB	Max. opterećenje / Max. load	Nazivni napon / Voltage	Kom./kutija / Pcs./ctn	EAN
234-401	bijela / white	H05VV-F 3G1	1,4 m	3	5V DC 2,1 A	16 A / 3500 W	250 V~	10	3856024403542
234-402	bijela / white	H05VV-F 3G1,5	3 m	3	5V DC 2,1 A	16 A / 3500 W	250 V~	10	3856024403559
234-411	crna / black	H05VV-F 3G1	1,4 m	3	5V DC 2,1 A	16 A / 3500 W	250 V~	10	3856024403566
234-412	crna / black	H05VV-F 3G1,5	3 m	3	5V DC 2,1 A	16 A / 3500 W	250 V~	10	3856024403573

 **Dvopolna sklopka**
Two-pole illuminated switch

 **Zaštita od direktnog kontakta**
Direct contact protection



Šifra / Art. No.	Kabel / Cable	Dužina / Length	Broj utičnica / Number of sockets	Max. opterećenje / Max. load	Nazivni napon / Voltage	Kom./kutija / Pcs./ctn	EAN
232-324	H05VV-F 3G1	1,4 m	3	16 A / 3500 W	250 V~	10	3858890446937
232-325	H05VV-F 3G1,5	3 m	3	16 A / 3500 W	250 V~	10	3858890446944
232-326	H05VV-F 3G1,5	5 m	3	16 A / 3500 W	250 V~	10	3856024406178
232-524	H05VV-F 3G1	1,4 m	5	16 A / 3500 W	250 V~	10	3858890447521
232-525	H05VV-F 3G1,5	3 m	5	16 A / 3500 W	250 V~	10	3858890447538
232-526	H05VV-F 3G1,5	5 m	5	16 A / 3500 W	250 V~	10	3856024406192



 **4 šuko utičnice + 2 USB punjača**
4 Schuko sockets + 2 USB chargers

 **Svjetlosni indikator napona**
Power indicator light

 **Nosač za montažu na zid ili stol**
Bracket for wall or table mounting

Šifra / Art. No.	Kabel / Cable	Dužina / Length	Broj utičnica / Number of sockets	Max. opterećenje / Max. load	Nazivni napon / Voltage	USB	Kom./kutija / Pcs./ctn	EAN
234-161	H05VV-F 3G1,5	1,4 m	4	16 A / 3500 W	250 V~	5V DC 2,1 A	16	3858890446340

PRENOSIVA UTIČNICA BEZ KABELA
REWIREABLE EXTENSION SOCKET



- Zaštita od direktnog kontakta**
Direct contact protection
- Dva načina pričvršćivanja na zid**
Two ways of attaching to the wall

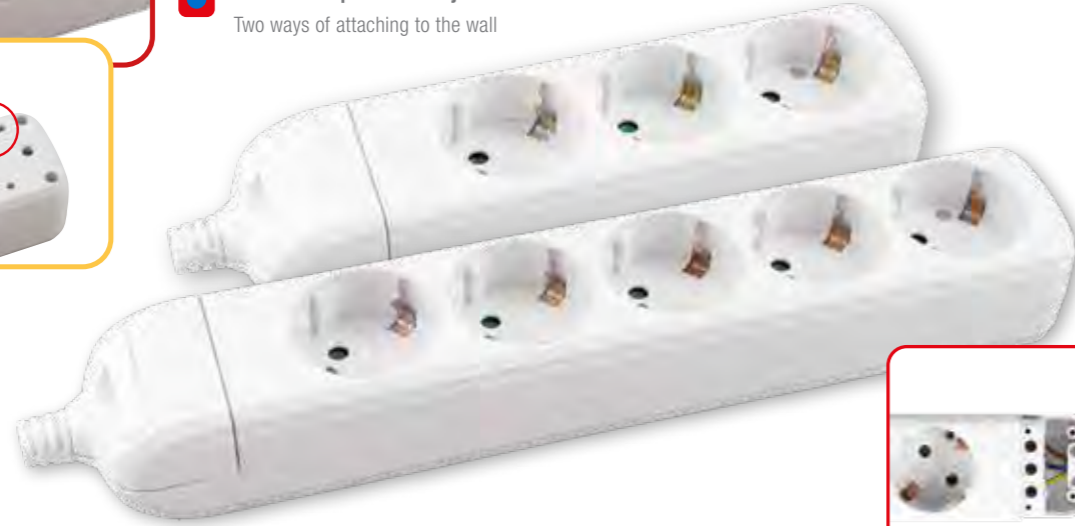
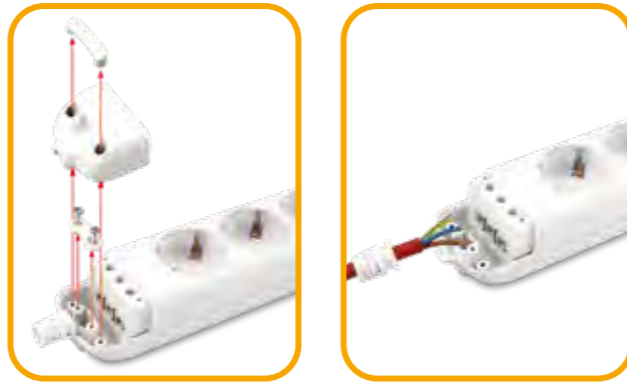

Šifra / Art. No.	Boja / Color	Sklopka / Switch	Broj utičnica / Number of sockets	Max. opterećenje / Max. load	Nazivni napon / Voltage	Stupanj zaštite / IP grade	Kom./kutija / Pcs./ctn	EAN
232-031	bijela / white	-	3	16 A / 3680 W	250 V~	IP20	10	3856024406055
232-051	bijela / white	-	5	16 A / 3680 W	250 V~	IP20	10	3856024406093

- Rastavljiv je samo dio za ožičenje**
Only the wiring part is detachable
- Dvopolna sklopka**
Two-pole illuminated switch



Šifra / Art. No.	Boja / Color	Sklopka / Switch	Broj utičnica / Number of sockets	Max. opterećenje / Max. load	Nazivni napon / Voltage	Stupanj zaštite / IP grade	Kom./kutija / Pcs./ctn	EAN
232-032	bijela / white	✓	3	16 A / 3680 W	250 V~	IP20	10	3856024406062
232-052	bijela / white	✓	5	16 A / 3680 W	250 V~	IP20	10	3856024406109



- Dva načina pričvršćivanja na zid**
Two ways of attaching to the wall
- Zaštita od direktnog kontakta**
Direct contact protection

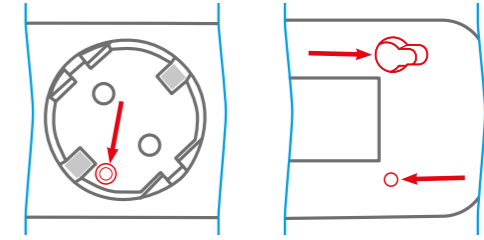

- Rastavljiv je samo dio za ožičenje**
Only the wiring part is detachable
- Dvopolna sklopka**
Two-pole illuminated switch

Šifra / Art. No.	Boja / Color	Sklopka / Switch	Broj utičnica / Number of sockets	Max. opterećenje / Max. load	Nazivni napon / Voltage	Stupanj zaštite / IP grade	Kom./kutija / Pcs./ctn	EAN
232-035	crna / black	-	3	16 A / 3680 W	250 V~	IP20	10	3856024406079
232-055	crna / black	-	5	16 A / 3680 W	250 V~	IP20	10	3856024406116

- Zaštita od direktnog kontakta**
Direct contact protection
- Rastavljiv je samo dio za ožičenje**
Only the wiring part is detachable



Šifra / Art. No.	Boja / Color	Sklopka / Switch	Broj utičnica / Number of sockets	Max. opterećenje / Max. load	Nazivni napon / Voltage	Stupanj zaštite / IP grade	Kom./kutija / Pcs./ctn	EAN
232-036	crna / black	✓	3	16 A / 3680 W	250 V~	IP20	10	3856024406086
232-056	crna / black	✓	5	16 A / 3680 W	250 V~	IP20	10	3856024406123

Commel®

Ugradbene utičnice za namještaj

Praktično rješenje za priključak na električnu energiju na mjestima na kojima trebate više prostora i ne želite narušiti estetiku.

Furniture sockets

A practical solution for connecting to electricity in places where you need more space and don't want to spoil the aesthetics.



POP UP UTIČNICE
POP UP SOCKETS

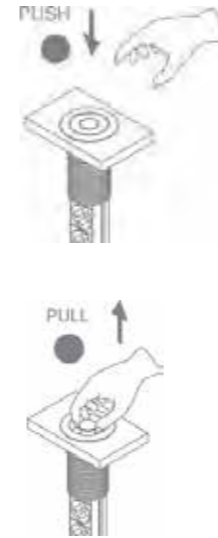

- Svjetlosni indikator napona
Power indicator light
- 3 šuko utičnice
3 Schuko sockets



- Dvopolna sklopka
Two-pole illuminated switch
- 3 šuko utičnice + 2 USB punjača
3 Schuko sockets + 2 USB chargers



Šifra / Art. No.	Kabel / Cable	Dužina / Length	Broj utičnica / Number of sockets	Max. opterećenje / Max. load	Nazivni napon / Voltage	USB	Kom./kutija / Pcs/ctn	EAN
232-181	H05VV-F 3G1,5	1,8 m	3	16 A / 3500 W	220-240 V~ 50/60Hz	-	20	3856024402217
234-181	H05VV-F 3G1,5	1,8 m	3	16 A / 3500 W	220-240 V~ 50/60Hz	2.1 A 5V	20	3856024402224

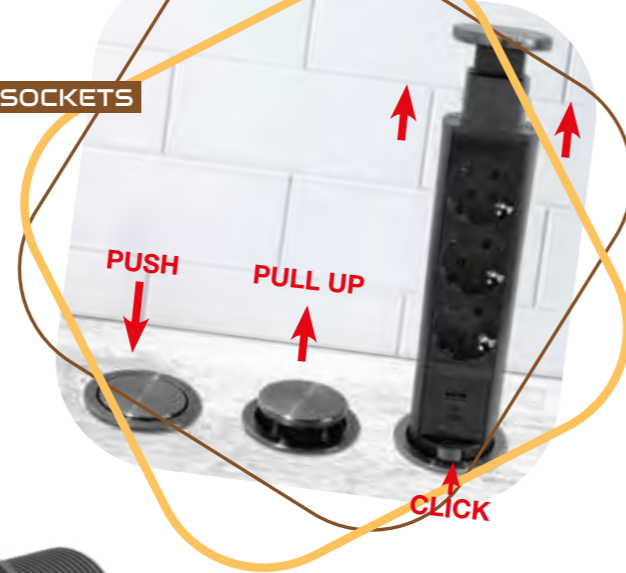
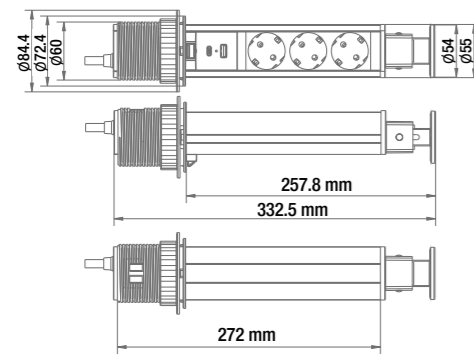

- Svjetlosni indikator napona
Power indicator light
- 3 šuko utičnice + 2 USB punjača
3 Schuko sockets + 2 USB chargers
- 2 dekorativna prstena
2 decorative rings



Šifra / Art. No.	Kabel / Cable	Dužina / Length	Broj utičnica / Number of sockets	Max. opterećenje / Max. load	Nazivni napon / Voltage	USB A+C	Kom./kutija / Pcs/ctn	EAN
235-121	H05VV-F 3G1,5	2 m	3	16 A / 3680 W	250 V~	5 V DC 3,1 A max 15.5 W	10	3856024405904

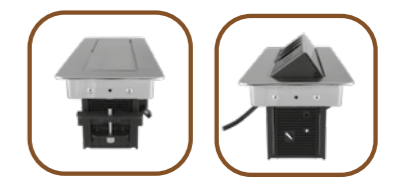

- 2 dekorativna prstena
2 decorative rings



- 2 dekorativna prstena
2 decorative rings

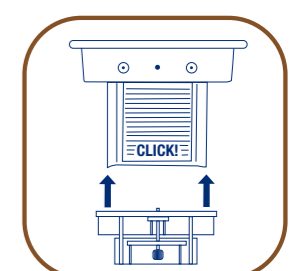
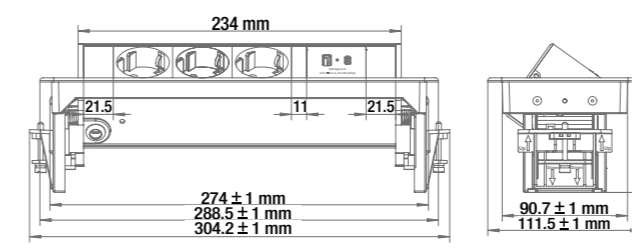
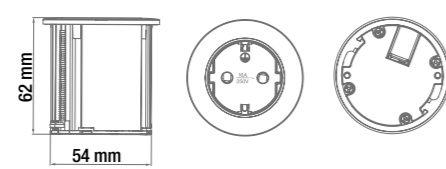

- Brzi sistem ugradnje
Fast mounting system

Šifra / Art. No.	Kabel / Cable	Boja / Color	Dužina / Length	Broj utičnica / Number of sockets	Max. opterećenje / Max. load	Nazivni napon / Voltage	Kom./kutija / Pcs/ctn	EAN
235-111	H05VV-F 3G1,5	bijela / white	2 m	1	16 A / 3680 W	250 V~	20	3856024405881
235-112	H05VV-F 3G1,5	crna / black	2 m	1	16 A / 3680 W	250 V~	20	3856024405898

Šifra / Art. No.	Kabel / Cable	Boja / Color	Dužina / Length	Broj utičnica / Number of sockets	Max. opterećenje / Max. load	Nazivni napon / Voltage	USB A+C	Kom./kutija / Pcs/ctn	EAN
235-101	H05VV-F 3G1,5	nikal / nickel	2 m	3	16 A / 3680 W	250 V~	5 V DC 3,1 A	10	3856024405867
235-102	H05VV-F 3G1,5	crna / black	2 m	3	16 A / 3680 W	250 V~	5 V DC 3,1 A	10	3856024405874



Industrijski utikači, natikači i utičnice

CEE Plugs, Connectors and Sockets



Šifra / Art. No.	Max. opterećenje / Max. load	Nazivni napon / Voltage	Polovi / Poles	Stupanj zaštite / IP grade	Kom./kutija / Pcs/ctn	EAN
280-101	16 A	400 V~	4P	IP44	1	3858890444100
280-102	32 A	400 V~	4P	IP44	1	3858890444117
280-103	16 A	400 V~	5P	IP44	1	3858890444124
280-104	32 A	400 V~	5P	IP44	1	3858890444131



Šifra / Art. No.	Max. opterećenje / Max. load	Nazivni napon / Voltage	Polovi / Poles	Stupanj zaštite / IP grade	Kom./kutija / Pcs/ctn	EAN
280-105	63 A	400 V~	5P	IP44	1	3858890444148



Šifra / Art. No.	Max. opterećenje / Max. load	Nazivni napon / Voltage	Polovi / Poles	Stupanj zaštite / IP grade	Kom./kutija / Pcs/ctn	EAN
280-113	16 A	400 V~	5P	IP67	1	3856024403863
280-114	32 A	400 V~	5P	IP67	1	3856024403870



 **Izmjena faze**
Phase inverter



Šifra / Art. No.	Max. opterećenje / Max. load	Nazivni napon / Voltage	Polovi / Poles	Stupanj zaštite / IP grade	Kom./kutija / Pcs/ctn	EAN
280-301	16 A	400 V~	5P	IP44	1	3858890444278
280-302	32 A	400 V~	5P	IP44	1	3858890444285



Šifra / Art. No.	Max. opterećenje / Max. load	Nazivni napon / Voltage	Polovi / Poles	Stupanj zaštite / IP grade	Kom./kutija / Pcs/ctn	EAN
281-101	16 A	400 V~	4P	IP44	1	3858890444155
281-102	32 A	400 V~	4P	IP44	1	3858890444162
281-103	16 A	400 V~	5P	IP44	1	3858890444179
281-104	32 A	400 V~	5P	IP44	1	3858890444186



Šifra / Art. No.	Max. opterećenje / Max. load	Nazivni napon / Voltage	Polovi / Poles	Stupanj zaštite / IP grade	Kom./kutija / Pcs/ctn	EAN
281-105	63 A	400 V~	5P	IP44	1	3858890444193



Šifra / Art. No.	Max. opterećenje / Max. load	Nazivni napon / Voltage	Polovi / Poles	Stupanj zaštite / IP grade	Kom./kutija / Pcs/ctn	EAN
281-113	16 A	400 V~	5P	IP67	1	3856024403887
281-114	32 A	400 V~	5P	IP67	1	3856024403894



Šifra / Art. No.	Max. opterećenje / Max. load	Nazivni napon / Voltage	Polovi / Poles	Stupanj zaštite / IP grade	Kom./kutija / Pcs/ctn	EAN
282-501	16 A	400 V~	4P	IP44	1	3858890444209
282-502	32 A	400 V~	4P	IP44	1	3858890444216
282-503	16 A	400 V~	5P	IP44	1	3858890444223
282-504	32 A	400 V~	5P	IP44	1	3858890444230



Šifra / Art. No.	Max. opterećenje / Max. load	Nazivni napon / Voltage	Polovi / Poles	Stupanj zaštite / IP grade	Kom./kutija / Pcs/ctn	EAN
282-505	63 A	400 V~	5P	IP44	1	3858890444247

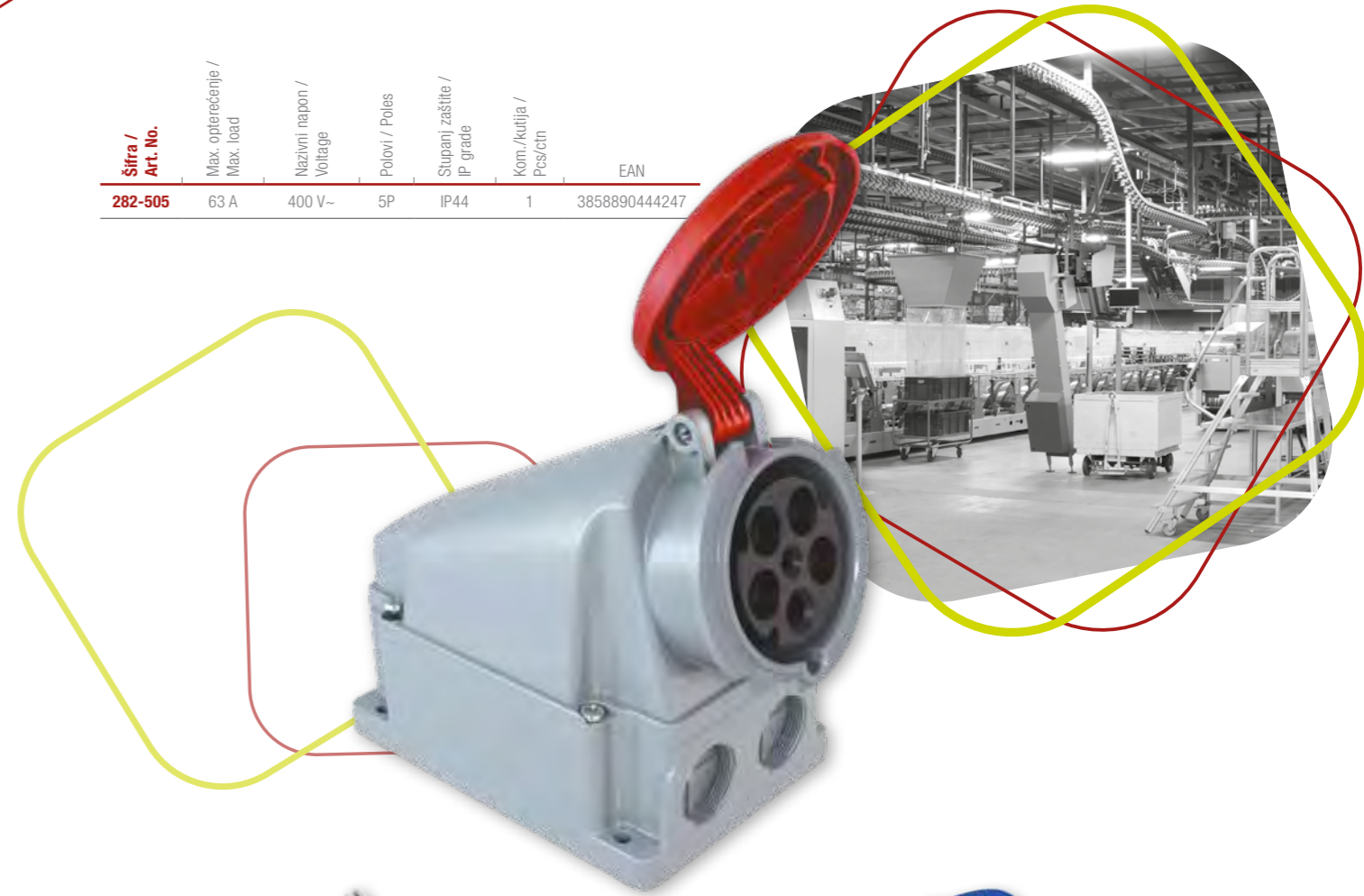

Šifra / Art. No.	Max. opterećenje / Max. load	Nazivni napon / Voltage	Polovi / Poles	Stupanj zaštite / IP grade	Kom./kutija / Pcs/ctn	EAN
280-501	16 A	400 V~	5P	IP44	1	3858890444254
280-502	32 A	400 V~	5P	IP44	1	3858890444261



Šifra / Art. No.	Max. opterećenje / Max. load	Nazivni napon / Voltage	Polovi / Poles	Stupanj zaštite / IP grade	Kom./kutija / Pcs/ctn	EAN
282-551	16 A	250/400 V~	5P	IP44	1	3858890444292

Šifra / Art. No.	Max. opterećenje / Max. load	Nazivni napon / Voltage	Polovi / Poles	Stupanj zaštite / IP grade	Kom./kutija / Pcs/ctn	EAN
282-301	16 A	400 V~	5P	IP44	1	3858890444308
282-302	32 A	400 V~	5P	IP44	1	3856024406758



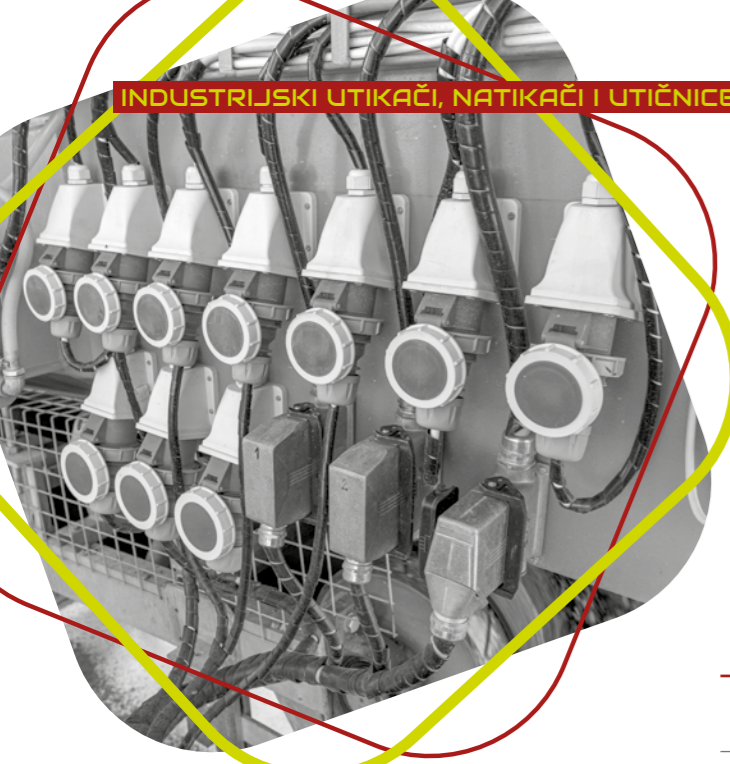

Šifra / Art. No.	Max. opterećenje / Max. load	Nazivni napon / Voltage	Polovi / Poles	Stupanj zaštite / IP grade	Kom./kutija / Pcs/ctn	EAN
280-201	16 A	250 V~	3P	IP44	1	3858890444315
280-202	32 A	250 V~	3P	IP44	1	3856024400145

Šifra / Art. No.	Max. opterećenje / Max. load	Nazivni napon / Voltage	Polovi / Poles	Stupanj zaštite / IP grade	Kom./kutija / Pcs/ctn	EAN
280-211	16 A	250 V~	3P	IP67	1	3856024403900



Šifra / Art. No.	Max. opterećenje / Max. load	Nazivni napon / Voltage	Polovi / Poles	Stupanj zaštite / IP grade	Kom./kutija / Pcs/ctn	EAN
281-201	16 A	250 V~	3P	IP44	1	3858890444322
281-202	32 A	250 V~	3P	IP44	1	3856024400152



Šifra / Art. No.	Max. opterećenje / Max. load	Nazivni napon / Voltage	Polovi / Poles	Stupanj zaštite / IP grade	Kom./kutija / Pcs/ctn	EAN
281-211	16 A	250 V~	3P	IP67	1	3856024403917



Šifra / Art. No.	Max. opterećenje / Max. load	Nazivni napon / Voltage	Polovi / Poles	Stupanj zaštite / IP grade	Kom./kutija / Pcs/ctn	EAN
282-511	16 A	250 V~	3P	IP44	1	3858890444339

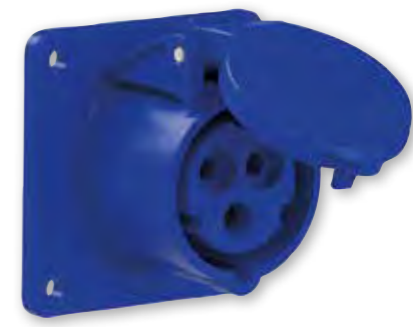

Šifra / Art. No.	Max. opterećenje / Max. load	Nazivni napon / Voltage	Polovi / Poles	Stupanj zaštite / IP grade	Kom./kutija / Pcs/ctn	EAN
282-311	16 A	250 V~	3P	IP44	1	3858890444346

 **Adapter za pretvaranje CEE standarda u šuko+talijanski standard**
 Plug adapter for converting CEE to Schuko+Italian standard

Šifra / Art. No.	Max. opterećenje / Max. load	Nazivni napon / Voltage	Polovi / Poles	Stupanj zaštite / IP grade	Kom./kutija / Pcs/ctn	EAN
284-101	16 A	250 V~	3P	IP20	1	3856024403405



 **Adapter za pretvaranje šuko standarda u CEE standard.**
 Plug adapter for converting Schuko to CEE standard

Šifra / Art. No.	Max. opterećenje / Max. load	Nazivni napon / Voltage	Polovi / Poles	Stupanj zaštite / IP grade	Kom./kutija / Pcs/ctn	EAN
284-102	16 A	250 V~	3P	IP20	10	3856024403412

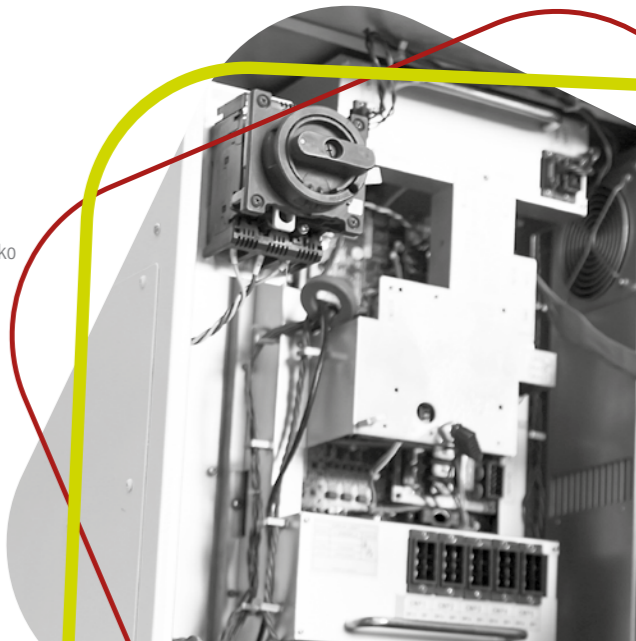

Utikači, natikači i utičnice

Različite izvedbe s ravnim ili kutnim ulazom kabela, stupnjem zaštite IP44 ili IP20 te kućištima od plastike ili gume pokrivaju sva područja primjene Commel utikača i natikača. Vijčani prihvat vodiča osigurava zaštitu od izvlačenja kabela i jamči sigurnost pri upotrebi.

Plugs, Connectors and Sockets

Various designs with straight or angular cable entry, IP44 or IP20 degree of protection, plastic or rubber housing, cover all areas of application of the Commel plugs and sockets. Screw terminals provide protection against cable pulling and guarantee safety when used.



Šifra / Art. No.	Boja / Color	Max. opterećenje / Max. load	Nazivni napon / Voltage	Stupanj zaštite / IP grade	Kom./kutija / Pcs./ctn	EAN
290-601	bijela/white	2,5 A	250 V~	IP20	10	3858890442670
290-602	crna/black	2,5 A	250 V~	IP20	10	3858890442687



Šifra / Art. No.	Boja / Color	Max. opterećenje / Max. load	Nazivni napon / Voltage	Stupanj zaštite / IP grade	Kom./kutija / Pcs./ctn	EAN
291-601	bijela/white	2,5 A	250 V~	IP20	10	3858890442694
291-602	crna/black	2,5 A	250 V~	IP20	10	3858890442700



Šifra / Art. No.	Boja / Color	Max. opterećenje / Max. load	Nazivni napon / Voltage	Stupanj zaštite / IP grade	Kom./kutija / Pcs./ctn	EAN
290-101	bijela/white	16 A	250 V~	IP20	10	3858883833928
290-102	crna/black	16 A	250 V~	IP20	10	3858883833935



Šifra / Art. No.	Boja / Color	Max. opterećenje / Max. load	Nazivni napon / Voltage	Stupanj zaštite / IP grade	Kom./kutija / Pcs./ctn	EAN
290-201	bijela/white	16 A	250 V~	IP20	10	3858883833942
290-202	crna/black	16 A	250 V~	IP20	10	3858883833959



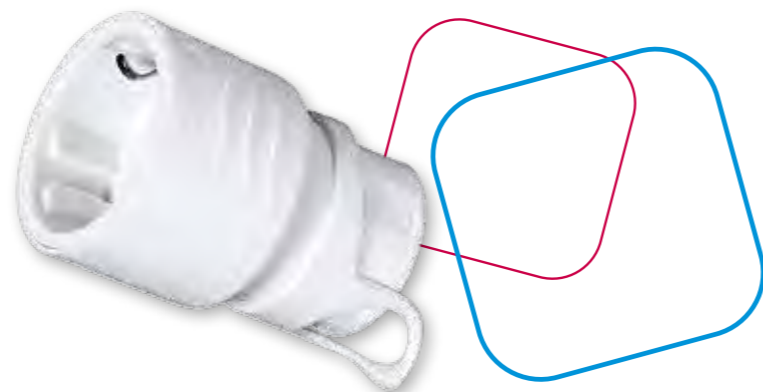

Šifra / Art. No.	Boja / Color	Max. opterećenje / Max. load	Nazivni napon / Voltage	Stupanj zaštite / IP grade	Kom./kutija / Pcs/ctn	EAN
291-101	bijela/white	16 A	250 V~	IP20	10	3858883833966
291-102	crna/black	16 A	250 V~	IP20	10	3858883833973

Šifra / Art. No.	Boja / Color	Max. opterećenje / Max. load	Nazivni napon / Voltage	Stupanj zaštite / IP grade	Kom./kutija / Pcs/ctn	EAN
291-201	bijela/white	16 A	250 V~	IP20	10	3858883833980
291-202	crna/black	16 A	250 V~	IP20	10	3858883833997



Šifra / Art. No.	Boja / Color	Max. opterećenje / Max. load	Nazivni napon / Voltage	Stupanj zaštite / IP grade	Kom./kutija / Pcs/ctn	EAN
290-501	bijela/white	16 A	250 V~	IP20	10	3858890442625
290-502	crna/black	16 A	250 V~	IP20	10	3858890442649



Gumirani
Rubber

Šifra / Art. No.	Boja / Color	Max. opterećenje / Max. load	Nazivni napon / Voltage	Stupanj zaštite / IP grade	Kom./kutija / Pcs/ctn	EAN
290-301	crna/black	16 A	250 V~	IP44	10	3858890444353

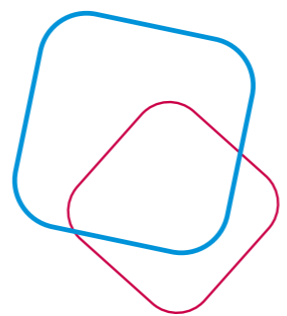

Gumirani
Rubber

Šifra / Art. No.	Boja / Color	Max. opterećenje / Max. load	Nazivni napon / Voltage	Stupanj zaštite / IP grade	Kom./kutija / Pcs/ctn	EAN
290-302	crna/black	16 A	250 V~	IP44	10	3858883831450



Šifra / Art. No.	Boja / Color	Max. opterećenje / Max. load	Nazivni napon / Voltage	Stupanj zaštite / IP grade	Kom./kutija / Pcs/ctn	EAN
290-308	crna/black	16 A	250 V~	IP54	30	3856024402293



Šifra / Art. No.	Boja / Color	Max. opterećenje / Max. load	Nazivni napon / Voltage	Stupanj zaštite / IP grade	Kom./kutija / Pcs/ctn	EAN
290-305	crveno-crna / red-black	16 A	250 V~	IP54	10	3858890446838
290-306	sivo-crna / grey-black	16 A	250 V~	IP54	10	3858890446852



Gumirani
Rubber

Šifra / Art. No.	Boja / Color	Max. opterećenje / Max. load	Nazivni napon / Voltage	Stupanj zaštite / IP grade	Kom./kutija / Pcs/ctn	EAN
291-301	crna/black	16 A	250 V~	IP20	10	3858890444360

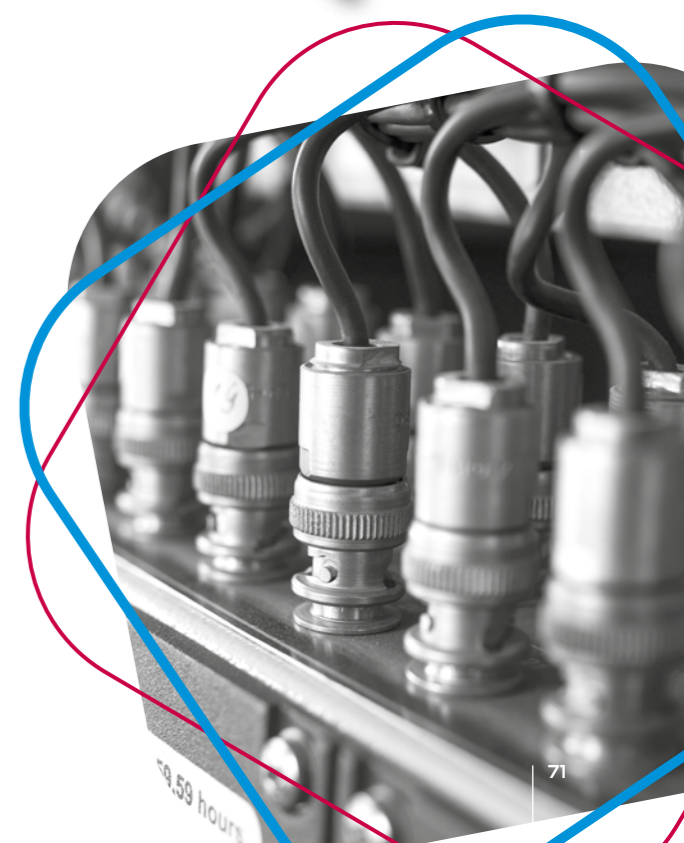

 Gumirani
Rubber

Šifra / Art. No.	Boja / Color	Max. opterećenje / Max. load	Nazivni napon / Voltage	Stupanj zaštite / IP grade	Kom./kutija / Pcs/ctn	EAN
291-304	crna/black	16 A	250 V~	IP44	10	3858890448405



 Gumirani
Rubber

Šifra / Art. No.	Boja / Color	Max. opterećenje / Max. load	Nazivni napon / Voltage	Stupanj zaštite / IP grade	Kom./kutija / Pcs/ctn	EAN
291-302	crna/black	16 A	250 V~	IP44	10	3858883831467



Šifra / Art. No.	Boja / Color	Max. opterećenje / Max. load	Nazivni napon / Voltage	Stupanj zaštite / IP grade	Kom./kutija / Pcs/ctn	EAN
291-308	crna/black	16 A	250 V~	IP20	20	3856024402309



Šifra / Art. No.	Boja / Color	Max. opterećenje / Max. load	Nazivni napon / Voltage	Stupanj zaštite / IP grade	Kom./kutija / Pcs/ctn	EAN
291-309	crna/black	16 A	250 V~	IP54	20	3856024402316



Šifra / Art. No.	Boja / Color	Max. opterećenje / Max. load	Nazivni napon / Voltage	Stupanj zaštite / IP grade	Kom./kutija / Pcs/ctn	EAN
291-305	crveno-crna / red-black	16 A	250 V~	IP54	10	3858890446845
291-306	sivo-crna / grey-black	16 A	250 V~	IP54	10	3858890446869



Šifra / Art. No.	Boja / Color	Max. opterećenje / Max. load	Nazivni napon / Voltage	Stupanj zaštite / IP grade	Kom./kutija / Pcs/ctn	EAN
6350	crna/black	16 A	400 V~	IP20	20	3858883838015



Šifra / Art. No.	Boja / Color	Max. opterećenje / Max. load	Nazivni napon / Voltage	Stupanj zaštite / IP grade	Kom./kutija / Pcs/ctn	EAN
292-101	crvena - crna/red - black	16 A	250 V~	IP54	1	3858890444469



Šifra / Art. No.	Boja / Color	Max. opterećenje / Max. load	Nazivni napon / Voltage	Kom./kutija / Pcs/ctn	EAN
293-701	bijela/white	2,5 A	250 V~	10	3858890445466
293-702	crna/black	2,5 A	250 V~	10	3858890445473



Razdjelnici, adapteri i punjači

Kada u stanu imate premali broj utičnih mjesta ili ste dobili neočekivane goste sa drugog kraja svijeta koji ne mogu priključiti svoj punjač za mobitel ili prijenosno računalo na Vašu električnu mrežu ili imate malu djecu koja guraju svoje prstiće u sve pa tako i u električne utičnice...ova kategorija rješava sve takve probleme.



Adaptors and chargers

When you have a small number of sockets at home, or you get unexpected guests from the other side of the world who can not plug in their mobile or laptop charger into your power supply, or you have small children sticking their fingers into everything including electrical sockets... This category solves all such problems.

Commel®



Šifra / Art. No.	Broj utičnica / Number of sockets	Boja / Color	Max. opterećenje / Max. load	Nazivni napon / Voltage	Kom./kutija / Pcs/ctn	EAN
6338-1	2	bijela / white	16 A / 3500 W	250 V~	10	3858883838404
6338-2	2	crna / black	16 A / 3500 W	250 V~	10	3858883838411
240-103	2	transparentna / transparent	16 A / 3500 W	250 V~	10	3858890448313
6338-3	3	bijela / white	16 A / 3500 W	250 V~	10	3858883838428
6338-4	3	crna / black	16 A / 3500 W	250 V~	10	3858883838435
240-113	3	transparentna / transparent	16 A / 3500 W	250 V~	10	3858890448320



Šifra / Art. No.	Broj utičnica / Number of sockets	Boja / Color	Max. opterećenje / Max. load	Nazivni napon / Voltage	Kom./kutija / Pcs/ctn	EAN
49111-1	3	bijela / white	2,5 A / 16 A	250 V~	10	3858883838541
49112-2	3	crna / black	2,5 A / 16 A	250 V~	10	3858883838510



Utičnice i razdjelnici sa sklopkom su praktično rješenje za uključivanje i isključivanje priključenih uređaja jednostavnim pritiskom prekidača. Savršenu primjenu pronalaze u kućanstvu za prekidanje napajanja elektroničkih uređaja za vrijeme mirovanja. Na taj način sprječavamo neželjenu potrošnju električne energije dok se uređaji ne koriste.

Sockets and adapters with a switch are a practical solution for turning on and off connected appliances by simply pressing the switch. Perfect application is found in the household for cutting off the power to appliances during their idle time. This prevents unwanted power consumption while the appliances are not in use.



Slika / Photo	Šifra / Art. No.	Broj utičnica / Number of sockets	Boja / Color	Max. opterećenje / Max. load	Nazivni napon / Voltage	Kom./kutija / Pcs/ctn	EAN
1	240-301	1	bijela / white	16 A	250 V~	10	3858890441512
2	240-302	2	bijela / white	16 A	250 V~	10	3858890441505
3	240-303	3	bijela / white	2,5 A / 16 A	250 V~	10	3858890441499
4	240-305	2	bijela / white	16 A	250 V~	10	3856024402910
5	240-306	3	bijela / white	2,5 A / 16 A	250 V~	10	3856024402927



1



2



4



3



5

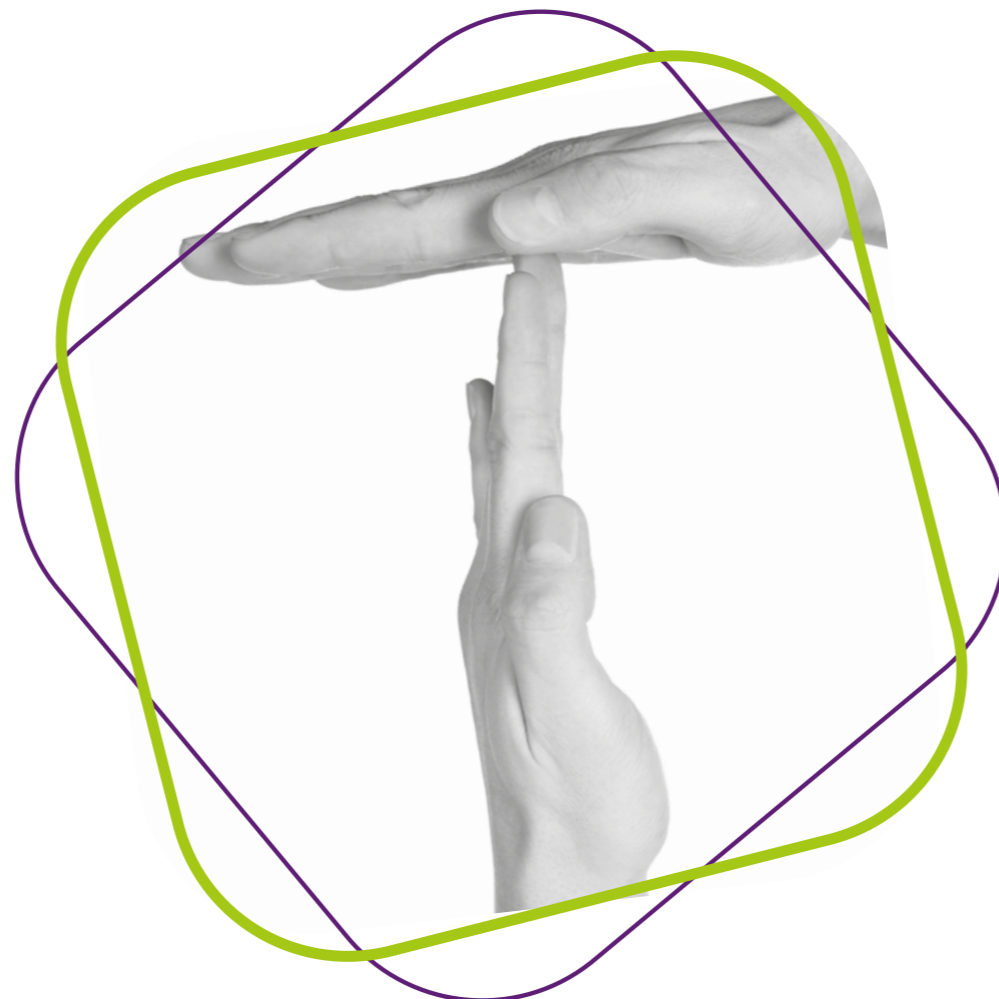

Šifra / Art. No.	Broj utičnica / Number of sockets	Boja / Color	Max. opterećenje / Max. load	Nazivni napon / Voltage	Stupanj zaštite / IP grade	Kom./kutija / Pcs/ctn	EAN
240-311	1	crna / black	16 A / 3680 W	250 V~	IP44	10	3856024405935



Šifra / Art. No.	Broj utičnica / Number of sockets	Boja / Color	Max. opterećenje / Max. load	Nazivni napon / Voltage	Stupanj zaštite / IP grade	Kom./kutija / Pcs/ctn	EAN
240-501	3	crna / black	16 A	250 V~	IP44	10	3858890443073

UTIČNICA S USB PUNJAČEM
SOCKET WITH USB CHARGER

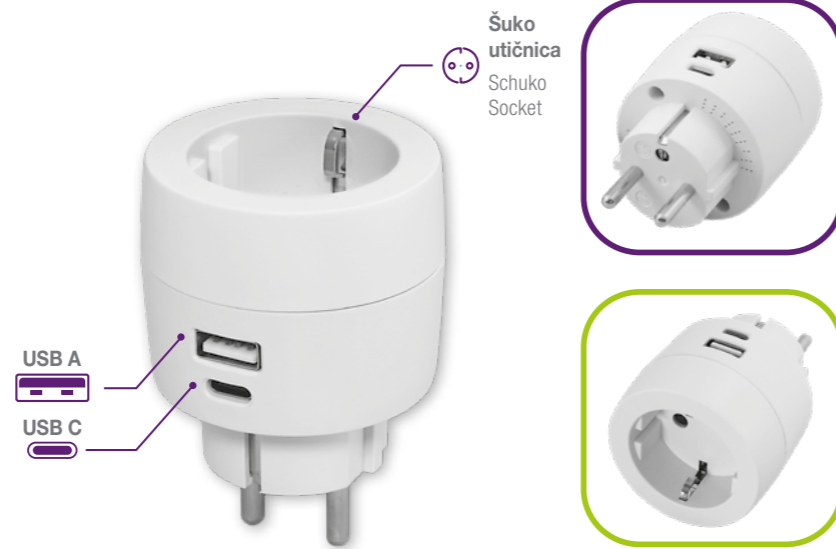

Šifra / Art. No.	Broj schuko utičnica / Number of Schuko sockets	Max. opterećenje / Max. load	Nazivni napon / Voltage	USB A+C	Stupanj zaštite / IP Grade	Kom./kutija / Pcs/ctn	EAN
240-801	1	16 A / 3680 W	250 V~ 50 Hz	5 V= 3,4 A max 17 W	IP20	50	3856024406147

USB PUNJAČ S KABELOM
USB CHARGER WITH CABLE

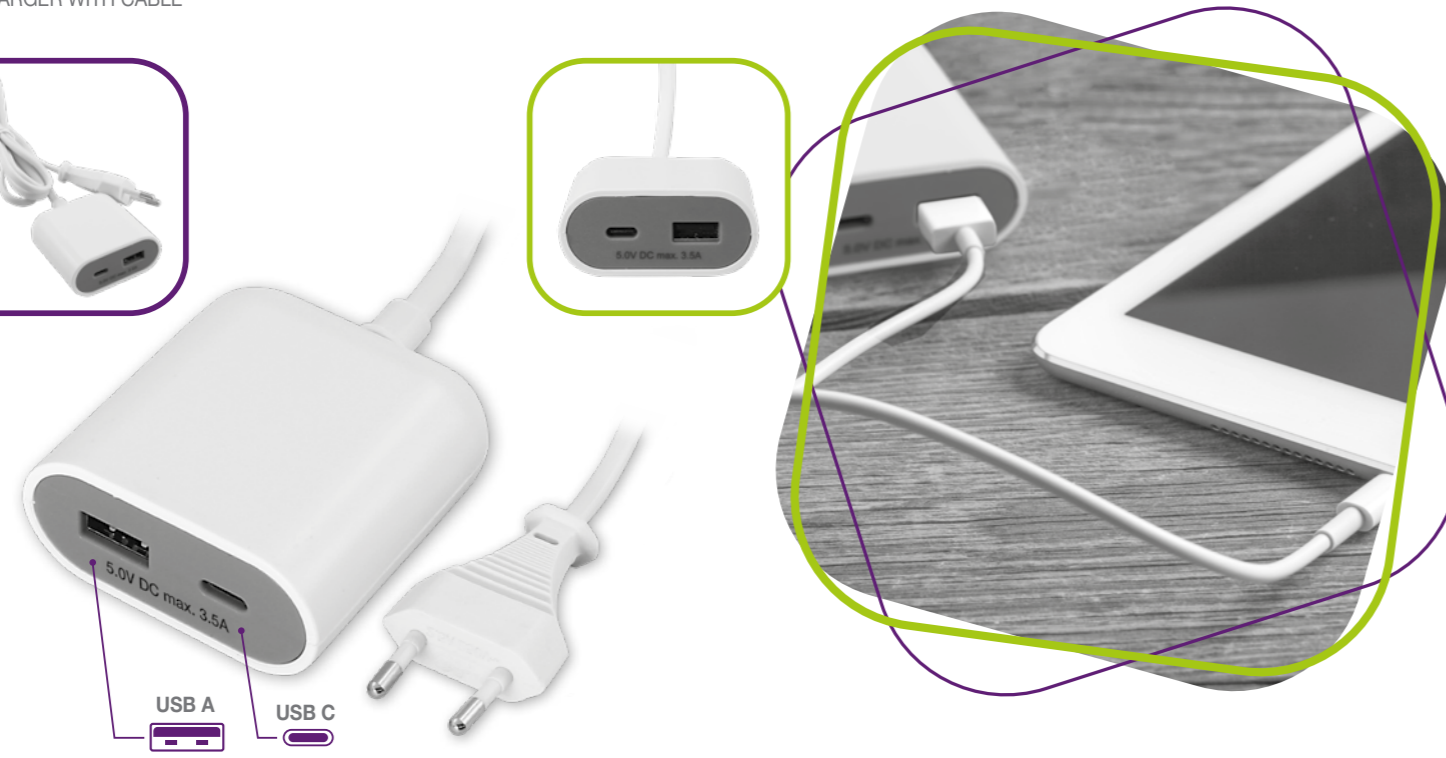

Šifra / Art. No.	Nazivni napon / Voltage	USB A+C	Dužina kabla / Cable length	Kabel / Cable	Stupanj zaštite / IP Grade	Kom./kutija / Pcs/ctn	EAN
245-101	110-250 V~ 50/60 Hz, 390 mA	5 V = 3,5 A max 17,5 W	1,5 m	H03VVH2-F 1,5 m	IP20	60	3856024406154

UNIVERZALNI PUTNI ADAPTER 250 V
TRAVEL ADAPTER 250 V

- Omogućuje priključivanje utikača različitih standarda u šuko utičnicu
Allows connection of different plug standards to a Schuko socket
- Zaštita od direktnog kontakta
Direct contact protection
- Putni adapter ne pretvara napone
Travel adapter does not convert voltages
- Visoka stijenka koja onemogućuje uključivanje samo jednog pina utikača
A high wall prevents the accidental plugging of just one plug pin



Šifra / Art. No.	Broj utičnica / Number of sockets	Boja / Color	Max. opterećenje / Max. load	Nazivni napon / Voltage	Kom./kutija / Pcs/ctn	EAN
480-103	1	bijela / white	10 A	250 V~	1	3856024406369

ZAŠTITA OD DIREKTOG KONTAKTA
DIRECT CONTACT PROTECTION

- Jednostavno postavljanje u bilo koju šuko utičnicu
Easy installation in any Schuko socket
- 10 komada u pakiranju
10 pieces in packaging



Šifra / Art. No.	Boja / Color	Kom./kutija / Pcs/ctn	EAN
48109-1	bijela / white	10	3858883838619

Kućna automatizacija

Živimo u doba kada je sve automatizirano ili obavlja svoju zadaću pritiskom samo jedne tipke. Commel kućna automatizacija namijenjena je olakšavanju dnevnih zadataka u kući, uredu i vrtu, ali i uštedi u kućanstvu.

Home Automation

We live in an age when everything is automated or performs its task by pressing just one button. Commel home automation is intended to facilitate the daily tasks in the home, office and garden, but also to make household savings.

Commel®



WIFI UTIČNICA
WIFI SOCKET

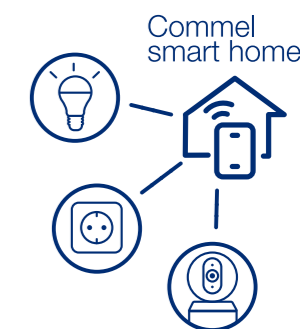

- Upravljajte električnim uređajima na daljinu putem pametnog telefona ili tableta bez obzira gdje se nalazite
Use smartphone or tablet to control your electrical appliances remotely from anywhere
- Funkcija programatora – za jednostavno podešavanje automatskog uključivanja i isključivanja
Timer function – for easy setting of auto power on and off

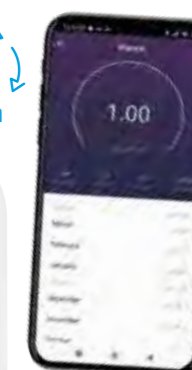

Commel IoT
App
download

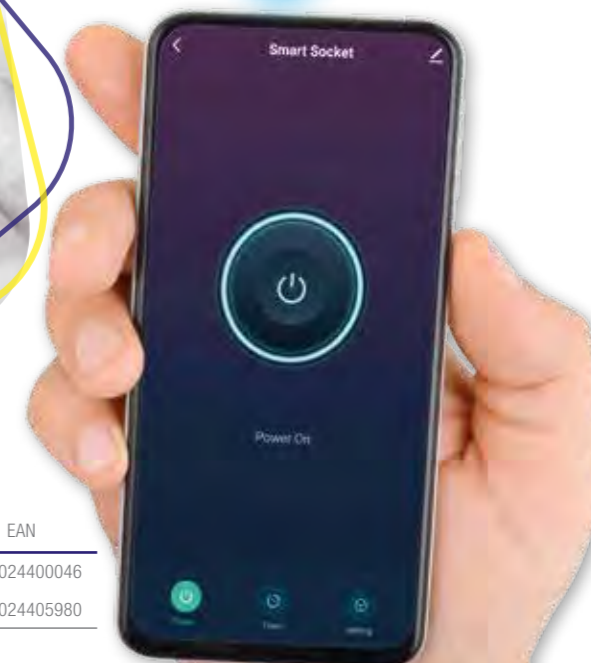

265-307

- + funkcija mjerača potrošnje električne energije
+ Timer function – for easy setting of auto power on and off

Šifra / Art. No.	Funkcija mjerača potrošnje / Power meter function	Max. opterećenje / Max. load	Nazivni napon / Voltage	WIFI	Kom. /kutija / Pcs./ctn	EAN
265-306	-	16 A / 3500 W	230 V~	2,4 GHz, 802.11b/g/n; +16dBm	60	3856024400046
265-307	✓	16 A / 3500 W	230 V~	2,4 GHz, 802.11b/g/n; +16dBm	60	3856024405980

WIFI SMART MINI PREKIDAČ
WIFI SMART MINI SWITCH



Commel IoT
App
download



Daljinski pristup i glasovno upravljanje
Remote access and voice control

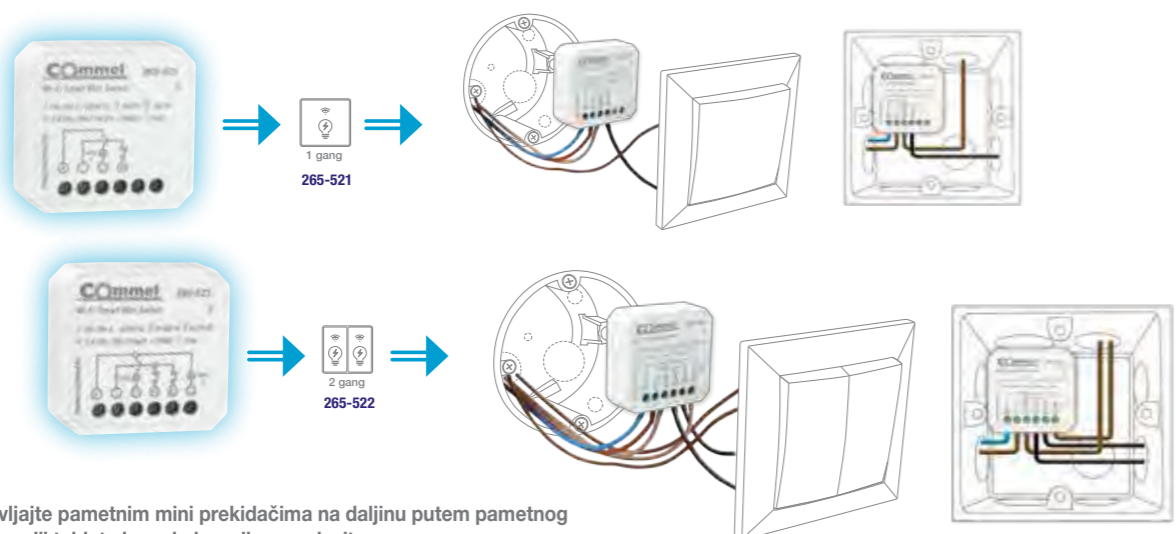

Upravljanje pametnim mini prekidačima na daljinu putem pametnog telefona ili tableta bez obzira gdje se nalazite
Use smartphone or tablet to control your smart mini switch remotely from anywhere

Funkcija programatora – za jednostavno podešavanje automatskog uključivanja i isključivanja
Timer function – for easy setting of auto power on and off

Šifra / Art. No.	Max. opterećenje / Max. load	Nazivni napon / Voltage	WiFi	Kom. /kutija / Pcs/ctn	Stupanj zaštite / IP grade	EAN
265-521	150 W / 500 W	100-240 V~	2,4 GHz, 802.11b/g/n; +16dBm	100	IP20	3856024404549
265-522	2 x 150 W / 2 x 500 W	100-240 V~	2,4 GHz, 802.11b/g/n; +16dBm	100	IP20	3856024404556



Commel IoT
App
download



WIFI PREKIDAČ
WIFI SWITCH

- Upravljanje pametnim prekidačima na daljinu putem pametnog telefona ili tableta bez obzira gdje se nalazite
Use smartphone or tablet to control your smart switch remotely from anywhere
- Funkcija programatora – za jednostavno podešavanje automatskog uključivanja i isključivanja
Timer function – for easy setting of auto power on and off

max. 800 W

max. 100 W

Šifra / Art. No.	Max. opterećenje / Max. load	Nazivni napon / Voltage	WiFi	Kom. /kutija / Pcs/ctn	Stupanj zaštite / IP grade	EAN
265-501	100 W / 800 W	220-240 V~	2,4 GHz, 802.11b/g/n; +16dBm	60	IP20	3856024400053
265-502	100 W / 800 W	220-240 V~	2,4 GHz, 802.11b/g/n; +16dBm	60	IP20	3856024400060

WIFI ŽARULJA
WIFI LIGHT BULB



Šifra / Art. No.	Snaga / Power	Svjjetlosni tok / Luminous flux	Temperatura svjetla / Color temperature	Životni vijek / Lifespan	Nazivni napon / Input voltage	WiFi	Baza / Base	Kom./Kutija / Pcs/ctn	Stupanj zaštite / IP grade	EAN
305-701	9 W	820 lm	3000-6500 K	25.000 h	220-240 V~	2,4 GHz, 802.11b/g/n; +16dBm	E27	5	IP20	3856024402644



Commel IoT App download



WIFI SMART PLAFONJERA
WIFI SMART CEILING LIGHT



Commel IoT App download



Šifra / Art. No.	Snaga / Power	Svjjetlosni tok / Luminous flux	Temperatura svjetla / Color temperature	Životni vijek / Lifespan	Promjer svjetiljke / Lamp diameter	Nazivni napon / Input voltage	WiFi	Kom./Kutija / Pcs/ctn	Stupanj zaštite / IP grade	EAN
407-801	1 x 12 W	1 x 1200 lm	3000-6000 K	25.000 h	260 mm	220-240 V~	2,4 GHz, 802.11b/g/n; +16dBm	20	IP20	3856024403603
407-802	1 x 24 W	1 x 2500 lm	3000-6000 K	25.000 h	380 mm	220-240 V~	2,4 GHz, 802.11b/g/n; +16dBm	10	IP20	3856024403610
407-803	1 x 36 W	1 x 3800 lm	3000-6000 K	25.000 h	490 mm	220-240 V~	2,4 GHz, 802.11b/g/n; +16dBm	10	IP20	3856024403627



Commel



Commel





Commel IoT
App
download

GET IT ON
Google Play



Download on the
App Store



WIFI SMART KUTNA SVJETILJKA
WIFI SMART CORNER LAMP



Šifra / Art. No.	Snaga / Power	Visina svjetiljke / Lamp height	Nazivni napon / Input voltage	WiFi	Kom./kutija / Pcs/ctn	Stupanj zaštite / IP grade	EAN
405-501	12 W	1,4 m	110-240 V DC 12 V	2,4 GHz, 802.11b/g/n; +16dBm	8	IP20	3856024403634

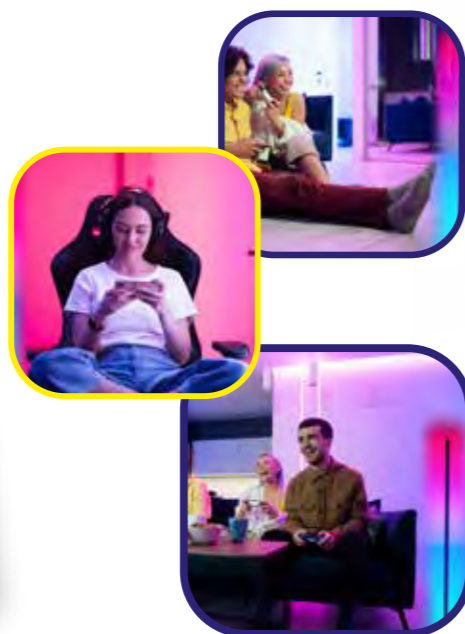

Commel
smart home

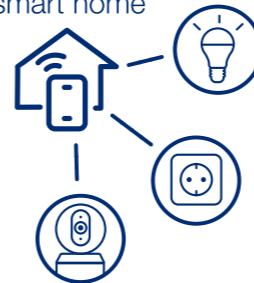

Utor za Micro SD karticu
Micro SD slot

- FHD**
Full HD
- V. Rotacija / rotation 90°**
H. Rotacija / rotation 355°
- Podržava / Support**
Micro SD
Max. 128 GB
- Podržava / Support**
WiFi 2.4 GHz / 5 GHz
- Upravljanje putem**
aplikacije
App Remote Control
- Detektor Pokreta**
Motion Detection
- Noćno snimanje**
do 5 m / Night Vision
up to 5 m
- Dvosmjerni Audio**
Two-Way Audio
- "Share" funkcija**
Share Control



Uključen set za stropnu
montažu
Ceiling mounting set
included



Commel IoT
App
download

GET IT ON
Google Play



Download on the
App Store



90°

355°



WIFI SMART KAMERA
WIFI SMART CAMERA

Šifra / Art. No.	Dimenzije / Dimensions	Dužina kabela / Cable length	Nazivni napon ulazno-izlazni / Input voltage input- output	WiFi	Video kompresija / Video compression	Kom./kutija / Pcs/ctn	Stupanj zaštite / IP grade	EAN
270-101	82 x 82 x 115 mm	1 m, USB-C	AC 100-240 V, 50/60 Hz, 0,3 A DC 5 V 1,5 A	2412 MHz~2472 MHz, 802.11 b/g/n 5.150 GHz~5.850 GHz, 802.11a	H.264	50	IP20	3856024405997

DIGITALNI PROGRAMATOR, TJEDNI
DIGITAL TIMER, WEEKLY

- 20 ON/OFF programa
20 ON/OFF programs
- Zaštita od direktnog kontakta
Direct contact protection
- Minimalni vremenski interval: 1 minuta
Minimum time interval: 1 minute
- Memorija postavki u slučaju nestanka struje
Memory that saves the settings in case of power failure
- Odbrojavanje vremena
Countdown timer
- 12-satni ili 24-satni prikaz
12-hour or 24-hour display
- LCD zaslon
LCD screen

Šifra / Art. No.	Max. opterećenje / Max. load	Nazivni napon / Voltage	Kom./kutija / Pcs/ctn	EAN
261-103	16 A / 3500 W	230 V~	10	3858890448467



MEHANIČKI PROGRAMATOR, DNEVNI
MECHANICAL DAILY TIMER



- 24-satno programiranje
24-hour programming
- Do 48 uključivanja/isključivanja dnevno
Up to 48 times on/off daily
- Minimalni vremenski interval: 30 minuta
Minimum time interval: 30 minutes
- Zaštita od direktnog kontakta
Direct contact protection

Šifra / Art. No.	Max. opterećenje / Max. load	Nazivni napon / Voltage	Kom./kutija / Pcs/ctn	Stupanj zaštite / IP grade	EAN
90821	16 A / 3500 W	230 V~	10	/	3858883838480
260-201	16 A / 3500 W	230 V~	10	IP44	3858890444612



- IP44 stupanj zaštite
IP44 degree of protection

PROGRAMATOR SA SENZOROM SVJETLA
TIMER WITH TWILIGHT SENSOR

- DUSK-DAWN - priključeni uređaj će se uključivati pri niskom ambijentalnom osvjetljenju a isključivati pri visokom ambijentalnom osvjetljenju.
DUSK-DAWN – the connected device turns on in low ambient light and turns off in high ambient light.
- 7 načina rada
7 working modes
- Zaštita od direktnog kontakta
Direct contact protection

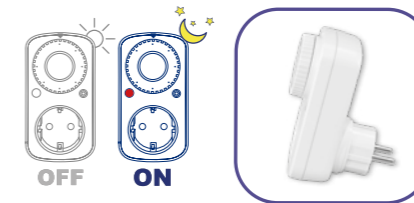

Šifra / Art. No.	Max. opterećenje / Max. load	Nazivni napon / Voltage	Kom./kutija / Pcs/ctn	Stupanj zaštite / IP grade	EAN
261-180	16(2) A max. 3600 W	230 V~ 50 Hz	48	IP20	3856024406680

MJERAČ POTROŠNJE ELEKTRIČNE ENERGIJE
POWER METER

- Veliki LCD zaslon
Large LCD screen
- Dvotarifni
Dual tariff
- Mogućnost mjerenja sljedećih parametara:
- snaga priključenog aparata (W)
- napon utičnice (V)
- frekvencija (Hz)
- struja (A)
- faktor snage (PF)
Ability to measure the following parameters:
- power of connected appliance (W)
- socket voltage (V)
- frequency (Hz)
- electric current (A)
- power factor (PF)
- Zaštita od direktnog kontakta
Direct contact protection
- Izračun cijene utrošene energije
Calculation of energy consumption



Šifra / Art. No.	Max. opterećenje / Max. load	Nazivni napon / Voltage	Kom./kutija / Pcs/ctn	EAN
430-106	16 A / 3680 W	230 V~	50	3856024402576

UTIČNICE S DALJINSKIM UPRAVLJAČEM
REMOTE CONTROL SOCKETS

- Domet: 30 m**
Remote range: 30 m
- Automatsko povezivanje**
Automatic connection
- Zaštita od direktnog kontakta**
Direct contact protection



	Šifra / Art. No.	Domet / Range	Max. opterećenje / Max. load	Nazivni napon / Voltage	Kom./kutija / Pcs/ctn	EAN
1	265-115	30 m	13 A / 3000 W	230 V~	10	3858890448474
2	265-116	30 m	13 A / 3000 W	230 V~	10	3858890448481

- Domet: 40 m**
Remote range: 40 m
- Automatsko povezivanje**
Automatic connection
- Zaštita od direktnog kontakta**
Direct contact protection



Šifra / Art. No.	Domet / Range	Max. opterećenje / Max. load	Nazivni napon / Voltage	Baterija / Battery	IP zaštita / IP Grade	Kom./kutija / Pcs/ctn	EAN
265-117	40 m	16 A / 3680 W	230 V~50Hz	1 x DC 3V CR2032	IP44	5	3856024405928

BEŽIČNI PREKIDAČ
WIRELESS SWITCH



Jednostavna upotreba bez prethodne instalacije žica. Prijemnik se ugrađuje u rasvjetno tijelo ili razvodnu kutiju, a tipkalo je dovoljno pričvrstiti vijcima ili obostrano ljepljivom trakom za ravnu površinu. Tipkalo koristi bateriju CR2032 i ima domet do 30 m što mu omogućava jednostavno uključivanje i isključivanje svjetla unutar prostorije. Brzo i jednostavno rješenje, bez potrebe za građevinskom izvedbom električnih instalacija.

Simple use without prior installation of wires. The receiver is installed in a light fixture or distribution box, and the button is sufficient to be fixed with screws or double-sided adhesive tape to a flat surface. The button uses a CR2032 battery and has a range of up to 30 m, which enables it to easily turn on and off the light inside the room. A quick and simple solution, without need for electrical installations.

- CR2032 - Baterija tipkala uključena u pakiranje**
CR2032 - Transmitter battery included
- Automatsko povezivanje**
Automatic connection

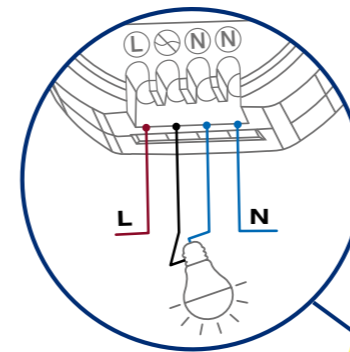

Prijemnik
Receiver

Tipkalo
Transmitter

Šifra / Art. No.	Radna temperatura /Working temperature	Domet / Range	Max. opterećenje / Max. load	Nazivni napon / Voltage	Kom./kutija / Pcs/ctn	EAN
265-121	0-35°C	30 m	1000 W	230 V~50 Hz	5	3856024406000

Multimetri i ispitivači napona

Kada je potrebno izmjeriti napon električne mreže, provjeriti otpor ili ispravnost vodiča, ova kategorija nudi svakom kućnom majstoru sve što mu je potrebno.

Multimeters and Voltage Testers

This category offers every handyman all he needs to measure the voltage of the power supply, check the resistance or functionality of the lead wires.



DIGITALNI MULTIMETAR
DIGITAL MULTIMETER



- Indikacija prazne baterije; osvijetljeni zaslon; mjerni vodovi u pakiranju
Low battery indication; illuminated screen; Test leads included



- CAT III; zaslon s 3 1/2 znamenke (maks. prikaz: 1999); mjerenje DC i AC napona, DC i AC struje, otpora, dioda, tranzistora hFE, provodljivosti, temperature i kapaciteta

CAT III; 3 1/2 digit display (max. reading: 1999); measuring DC and AC voltage, direct current, resistance, capacity, temperature, test diodes and perform audible tests of conductivity and circuits

Šifra / Art. No.	AC napon / AC voltage	DC napon / DC voltage	DC struja / DC current	Otpor / Resistance	Temperatura °C / Temperature °C	Temperatura °F / Temperature °F	Kapacitet / Capacitance	Tranzistor hFE test / Transistor hFE test	Baterija u pakiranju / Battery Included	Kom./kutija / Pcs/cn	EAN
450-104	2 V - 300 V	200 mV - 300 V	200 µA - 10 A	200 Ω - 20 MΩ	-20°C - 1000°C	0°F - 1800°F	20 nF - 1000 µF	PNP & NPN	3 x 1,5 V AAA	44	3856024403641

- CAT III; zaslon s 3 1/2 znamenke (maksimalni prikaz: 1999); provjera dioda i provodljivosti
CAT III; 3 1/2 digit display (max. reading: 1999); Testing diode and continuity

- Indikacija prazne baterije; mjerni vodovi u pakiranju
Low battery indication; Test leads included



Šifra / Art. No.	AC napon / AC voltage	DC napon / DC voltage	DC struja / DC current	Otpor / Resistance	Baterija u pakiranju / Battery Included	Kom./kutija / Pcs/cn	EAN
450-102	200 V - 300 V	200 mV - 300 V	20 µA - 10 A	200 Ω - 2 MΩ	1 x 9 V DC	60	3858890443769

DIGITALNI MULTIMETAR
DIGITAL MULTIMETER



- CAT III; zaslon s 3 ½ znamenke (maksimalni prikaz: 1999); provjera dioda
CAT III; 3 ½ digit display (max. reading: 1999); Testing diode
- Test baterija (1,5 V i 9 V); Indikacija prazne baterije
Battery test (1.5 V i 9 V); Low battery indication

Šifra / Art. No.	AC napon / AC voltage	DC napon / DC voltage	DC struja / DC current	Otpor / Resistance	Baterija u pakiranju / Battery included	Kom./kutija / Pcs/ctn	EAN
450-103	200 V - 300 V	200 mV - 300 V	2000 µA - 200 mA	200 Ω - 2000 kΩ	1 x 12 V, 23 A	42	3858890443776



DIGITALNA STRUJNA KLIJEŠTA
DIGITAL CLAMP METER

- CAT III; zaslon s 3 ½ znamenke (maksimalni prikaz: 1999)
CAT III; 3 ½ digit display (max. reading: 1999)
- Indikacija prazne baterije; mjerni vodovi u pakiranju
Low battery indication; Test leads included
- Funkcija zadržavanja podataka; Zaštita od preopterećenja
Data-hold function; Overload protection



Šifra / Art. No.	AC napon / AC voltage	DC napon / DC voltage	AC struja / AC current	Otpor / Resistance	Baterija u pakiranju / Battery included	Kom./kutija / Pcs/ctn	EAN
450-201	300 V	300 V	20 A - 400 A	2000 Ω - 200 kΩ	3 x 3V, CR2032	60	3856024403658

DETEKTOR NAPONA - BEZKONTAKTNI
NON-CONTACT VOLTAGE DETECTOR



- CAT III; sigurna detekcija napona - bez kontakta
CAT III; Safe, non-contact voltage detection
- Svjetlosna i zvučna signalizacija
LED and buzzer indication

Šifra / Art. No.	Raspon napona / Voltage range	Baterija u pakiranju / Batteries included	Kom./kutija / Pcs/ctn	EAN
445-201	70-1000 V~ 50/60 Hz	2 x 1,5 V, AAA	60	3858890443752

ISPITIVAČ NAPONA
VOLTAGE TESTER

- CAT III; LED indikacija u visini izmjerenog napona
CAT III; LED lights up to the voltage reading
- Indikacija polariteta DC napona
DC voltage polarity indication



Šifra / Art. No.	Raspon napona / Voltage range	Frekvencija / Frequency	Baterija u pakiranju / Batteries included	Kom./kutija / Pcs/ctn	EAN
445-101	6 V / 12 V / 24 V / 50 V / 120 V / 230 V / 400 V	50-60 Hz	2 x LR44 1.5 V	48	3858890443745

ISPITIVAČI NAPONA
VOLTAGE TESTERS



Šifra / Art. No.	Dužina / Length	Raspon napona / Voltage range	Kom./kutija / Pcs/ctn	EAN
445-301	140 mm	200 - 250 V ~	20	3856024401845

Šifra / Art. No.	Dužina / Length	Raspon napona / Voltage range	Kom./kutija / Pcs/ctn	EAN
445-302	190 mm	200 - 250 V ~	20	3856024401852

Zvonca

Commel električna i bežična zvonca namijenjena su za kućnu upotrebu ali isto tako mogu naći svoju primjenu i u drugim područjima. Veliki domet bežičnih zvonaca garantira jasnu i nesmetanu komunikaciju između tipkala i samog zvonca. Širok izbor dizajna omogućava svakom kupcu pronaći zvonce po svom ukusu koje će mu ujedno uljepšavati unutarnji prostor.

Doorbells

Commel electric and wireless doorbells are primarily intended for home use, but can also be found in other areas. A long wireless range of wireless doorbells guarantees clear and smooth communication between the push button and the doorbell itself. A wide selection of design allows everyone to find doorbells for their taste, which will also embellish their interior space.



BEŽIČNA ZVONCA WIRELESS DOORBELLS



Automatsko povezivanje LED indikator
Kućište od sjajne plastike
Auto-learning code
LED indicator
Glossy plastic housing

36 melodija
36 melodies

3 načina rada:
- zvano + svjetlosna indikacija
- samo zvono
- samo svjetlosna indikacija

3 function options:
- ring + LED flash
- ring only
- LED flash only

Slika / Photo	Šifra / Art. No.	Broj melodija / Number of melodies	Jačina zvona / Bell volume	Domet / Range	Tipkalo / Transmitter	Zvonca / Bell	Kom./Kutija / Pcs/ctn	EAN
1	411-107	36	70 dB	300 m			10	3858883839135
2	411-108	36	70 dB	300 m	DC 3V CR2032 baterija u pakiranju / battery included	2 x 1,5V DC AA baterije nisu u pakiranju / batteries not included	10	3858890443691
3	411-109	36	70 dB	300 m			10	3858890443684



Šifra / Art. No.	Broj melodija / Number of melodies	Jačina zvona / Bell volume	Domet / Range	Tipkala / Transmitter	Zvonce / Bell	Kom./kutija / Pcs/ctn	EAN
411-110	32	83 dB	100 m	DC 3V CR2032 baterija u pakiranju / battery included	2 x 1,5V DC AA baterije nisu u pakiranju / batteries not included	10	3856024402682



Kućiste obloženo tkaninom
Case covered with textile

Bez žica
No wires required

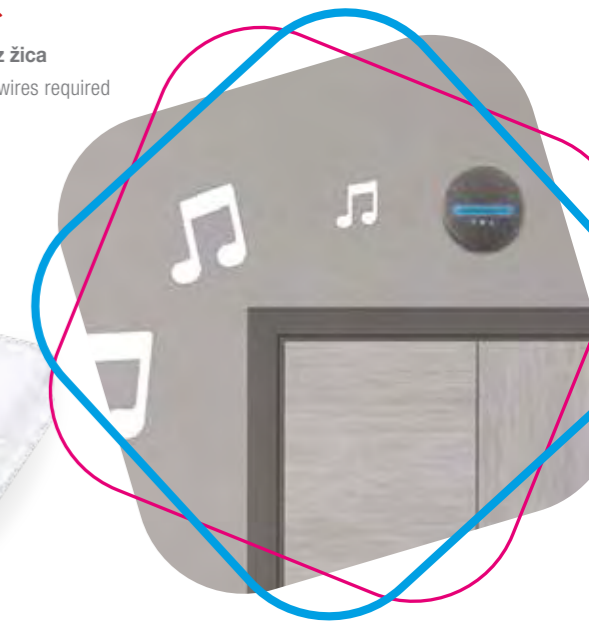

Šifra / Art. No.	Broj melodija / Number of melodies	Glasnoća zvonce / Bell volume	Domet / Range	Baterija tipkala / Transmitter battery	Baterija zvonce / Bell battery	Frekvencija / frequency	Najveća radio frekvencijska snaga / Max. radio frequency power	Kom./kutija / Pcs/ctn	EAN
411-112	38	85 dB	200 m	1 x DC 3V CR2032	3 x 1.5 V AA (not included)	433,92 MHz	< 5dBm	10	3856024405669



Šifra / Art. No.	Broj melodija / Number of melodies	Jačina zvona / Bell volume	Domet / Range	Tipkala / Transmitter	Zvonce / Bell	Kom./kutija / Pcs/ctn	EAN
411-106	36	70 dB	300 m	DC 3V CR2032 baterija u pakiranju / battery included	2 x 1,5V DC AA baterije nisu u pakiranju / batteries not included	10	3858883838473



Kućiste obloženo tkaninom
Case covered with textile

Bez žica
No wires required



Plavi LED indikator
Blue LED indicator

Šifra / Art. No.	Broj melodija / Number of melodies	Glasnoća zvonce / Bell volume	Domet / Range	Baterija tipkala / Transmitter battery	Baterija zvonce / Bell battery	Frekvencija / frequency	Najveća radio frekvencijska snaga / Max. radio frequency power	Kom./kutija / Pcs/ctn	EAN
411-114	36	80 dB	200 m	1 x DC 3V CR2032	3 x 1.5 V AA (not included)	433,92 MHz	< 5dBm	5	3856024406635

KINETIČKA ZVONCA
KINETIC DOORBELL



Bez baterija i žica
No batteries, no wires required

Šifra / Art. No.	Broj melodija / Number of melodies	Jačina zvona / Bell volume	Domet / Range	Tipkalo / Transmitter	Zvonca / Bell	Kom./kutija / Pcs/ctn	EAN
411-111	36	80 dB	100 m	kinetičko / kinetic	100-240 V~	10	3856024403399

KINETIČKO ZVONCE S NOĆNIM SVJETLOM
KINETIC DOORBELL WITH NIGHT LIGHT



Bez baterija i žica
No batteries, no wires required

Plavi LED indikator
Blue LED indicator



Noćno svjetlo
Night light



Noćni senzor
Night sensor

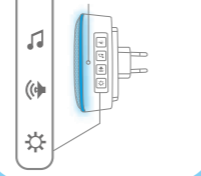

Kućiste obloženo tkaninom
Case covered with textile

Šifra / Art. No.	Broj melodija / Number of melodies	Glasnoća zvonce / Bell volume	Domet / Range	Tipkalo / Transmitter	Zvonca / Bell	Frekvencija / frequency	Kom./kutija / Pcs/ctn	EAN
411-113	36	80 dB	150 m	kinetičko / kinetic	220-240 V~ 50 Hz	433,92 MHz	5	3856024406260

ZVONCE ZA DIN ŠINU
DIN RAIL BELL



Šifra / Art. No.	Jačina zvona / Bell volume	Nazivni napon / Voltage	Kom./kutija / Pcs/ctn	EAN
410-201	80 dB	220 - 240 V~ 50/60 Hz	12	3858890448603

ELEKTRIČNA ZVONCA
ELECTRIC DOORBELLS



Slika / Photo	Šifra / Art. No.	Broj melodija / Number of melodies	Jačina zvona / Bell volume	Nazivni napon / Voltage	Kom./kutija / Pcs/ctn	EAN
1	410-104	1	80 dB	230 V~	10	3856024402255
2	410-105	1	80 dB	230 V~	10	3856024402262
3	410-106	1	80 dB	230 V~	10	3856024402279

Portafoni

Commel portafoni omogućuju Vam glasovnu i vizualnu komunikaciju s posjetiteljima. Svi modeli dolaze s robusnim vanjskim jedinicama pojačane otpornosti na loše vremenske uvjete.

Door Phones

Commel video door phones allow you voice and visual communication with visitors. All models come with robust outdoor units with increased resistance to bad weather conditions.

Commel®



Sifra / Art. No.	Veličina zaslona / Screen size	Broj melodija / Number of melodies	Kom./Kutija / Pcs./ctn	EAN
501-104	7"	16	4	3858890447262



- 7" zaslon u boji
16 melodija zvona
Handsfree komunikacija
7" color screen
16 ringtones
Handsfree communication

- Mogućnost otključavanja 2 vrata
Napajanje: DC 12 V 1100 mA
Noćno snimanje: 1 m
Unlocking two doors
Power supply: DC 12 V 1100 mA
Night recording: 1 m

- Dimenzije unutarnje jedinice: 215 x 152 x 18 mm
Dimenzije vanjske jedinice: 53 x 131 x 47 mm
Stupanj zaštite vanjske jedinice: IP44
Indoor unit dimensions: 215 x 152 x 18 mm
Outdoor unit dimensions: 53 x 131 x 47 mm
Outdoor unit protection degree: IP44



Šifra / Art. No.	Veličina zaslona / Screen size	Broj melodija / Number of melodies	Kom./kutija / Pcs/ctn	EAN
501-105	4,3"	16	8	3858890447279

- 4,3" zaslon u boji
16 melodija zvon
Handsfree komunikacija
4.3" color screen
16 ringtones
Handsfree communication

- Mogućnost otključavanja 2 vrata
Napajanje: DC 12 V 1100 mA
Noćno snimanje: 1 m
Unlocking two doors
Power supply: DC 12 V 1100 mA
Night recording: 1 m

- Dimenzije unutarnje jedinice: 136 x 143 x 18,5 mm
Dimenzije vanjske jedinice: 53 x 131 x 47 mm
Stupanj zaštite vanjske jedinice: IP44
Indoor unit dimensions: 136 x 143 x 18,5 mm
Outdoor unit dimensions: 53 x 131 x 47 mm
Outdoor unit protection degree: IP44



Šifra / Art. No.	Veličina zaslona / Screen size	Broj melodija / Number of melodies	Kom./kutija / Pcs/ctn	EAN
501-205	4,3"	16	4	3858890449952

- 4,3" zaslon u boji
16 melodija zvon
Handsfree komunikacija
4.3" color screen
16 ringtones
Handsfree communication

- Mogućnost otključavanja 2 vrata
Napajanje: DC 12 V 1100 mA
Noćno snimanje: 1 m
Unlocking two doors
Power supply: DC 12 V 1100 mA
Night recording: 1 m

- Dimenzije unutarnje jedinice: 136 x 143 x 18,5 mm
Dimenzije vanjske jedinice: 118 x 205 x 80 mm
Stupanj zaštite vanjske jedinice: IP44
Indoor unit dimensions: 136 x 143 x 18,5 mm
Outdoor unit dimensions: 118 x 205 x 80 mm
Outdoor unit protection degree: IP44



Šifra / Art. No.	Broj melodija / Number of melodies	Kom./kutija / Pcs/ctn	EAN
502-103	1	20	3858890449938



Šifra / Art. No.	Broj melodija / Number of melodies	Kom./kutija / Pcs/ctn	EAN
502-203	1	10	3858890449945

- 4,3" zaslon u boji
16 melodija zvon
Handsfree komunikacija
4.3" color screen
16 ringtones
Handsfree communication

Ventilatori

Commel ventilatori namijenjeni su ugradnji u otvore od 100, 120 i 150 mm. U ponudi su i modeli s mogućnošću podešavanja odgode gašenja. Niska potrošnja električne energije i niska razina buke također su odlike Commel ventilatora.

Exhaust Fans

Energy-saving and low-noise exhaust fans from Commel are designed for installation into ventilation shafts of 100, 120 and 150 mm. There are models that also have delay timer.



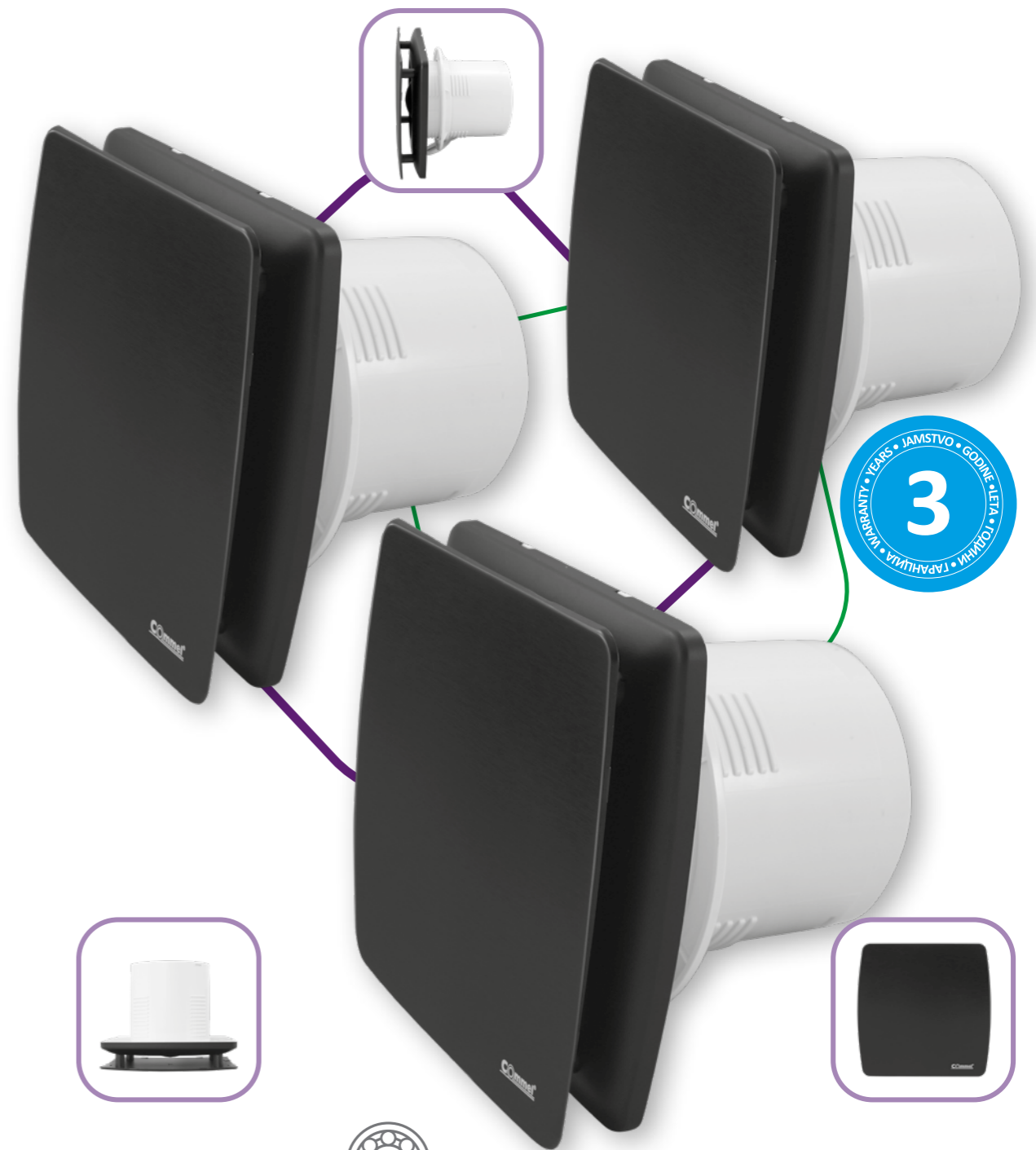
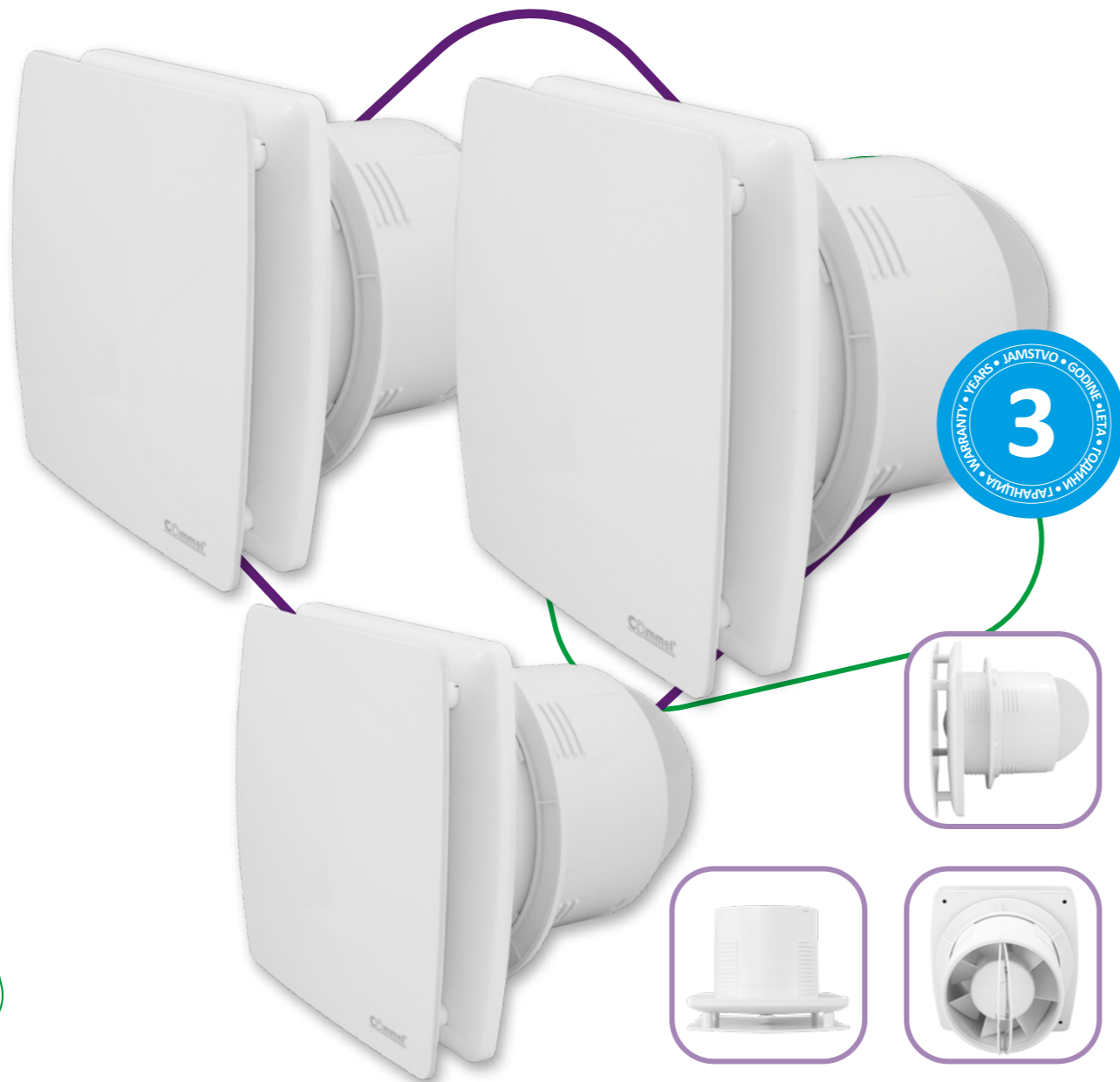

Šifra / Art. No.	Snaga / Power	Max. protok zraka / Max air flow	Promjer otvora za ugradnju / Mounting diameter	Razina buke / Noise level	Brzina rotacije / Motor rotation	Stupanj zaštite / IP grade	Odgoda gašenja / timer Shut off delay / timer	Nazivni napon / Voltage	Kom./kutija / Pcs/ctn	EAN
420-101	12W	130 m³/h	100 mm	34 db	2400 rpm	IPX2	-	220-240 V~ 50 Hz	20	3858883835601
420-102	12W	130 m³/h	100 mm	34 db	2400 rpm	IPX2	✓	220-240 V~ 50 Hz	20	3858883835618
420-111	16W	240 m³/h	120 mm	34 db	2200 rpm	IPX2	-	220-240 V~ 50 Hz	20	3858890446074
420-112	16W	240 m³/h	120 mm	34 db	2200 rpm	IPX2	✓	220-240 V~ 50 Hz	20	3858890446067
420-121	18W	320 m³/h	150 mm	35 db	2000 rpm	IPX2	-	220-240 V~ 50 Hz	20	3858890446050
420-122	18W	320 m³/h	150 mm	35 db	2000 rpm	IPX2	✓	220-240 V~ 50 Hz	20	3858890446043



 **Motor s kugličnim ležajem**
Ball bearing motor



 **Mogućnost stropne i zidne montaže**
Possibility of ceiling and wall mounting

 **Motor s kugličnim ležajem**
Ball bearing motor



 **Mogućnost stropne i zidne montaže**
Possibility of ceiling and wall mounting

Šifra / Art. No.	Snaga / Power	Boja / Color	Max. protok zraka / Max air flow	Promjer otvora za ugradnju / Mounting diameter	Razina buke / Noise level	Bizina rotacije / Motor rotation	Stupanj zaštite / IP grade	Odgoda gašenja / timer / Shut off delay / timer	Nazivni napon / Voltage	Kom./kutija / Pcs./ctn	EAN
420-201	12W	bijela/white	95 m³/h	100 mm	34 db	2200 rpm	IPX4	-	220-240 V~ 50 Hz	20	3856024406826
420-202	12W	bijela/white	95 m³/h	100 mm	34 db	2200 rpm	IPX4	✓	220-240 V~ 50 Hz	20	3856024406833
420-211	16W	bijela/white	160 m³/h	120 mm	34 db	2000 rpm	IPX4	-	220-240 V~ 50 Hz	24	3856024406864
420-212	16W	bijela/white	160 m³/h	120 mm	34 db	2000 rpm	IPX4	✓	220-240 V~ 50 Hz	24	3856024406871
420-221	18W	bijela/white	240 m³/h	150 mm	35 db	1850 rpm	IPX4	-	220-240 V~ 50 Hz	16	3856024406901
420-222	18W	bijela/white	240 m³/h	150 mm	35 db	1850 rpm	IPX4	✓	220-240 V~ 50 Hz	16	3856024406918

Šifra / Art. No.	Snaga / Power	Boja / Color	Max. protok zraka / Max air flow	Promjer otvora za ugradnju / Mounting diameter	Razina buke / Noise level	Bizina rotacije / Motor rotation	Stupanj zaštite / IP grade	Odgoda gašenja / timer / Shut off delay / timer	Nazivni napon / Voltage	Kom./kutija / Pcs./ctn	EAN
420-203	12W	crna/black	95 m³/h	100 mm	34 db	2200 rpm	IPX4	-	220-240 V~ 50 Hz	20	3856024406840
420-204	12W	crna/black	95 m³/h	100 mm	34 db	2200 rpm	IPX4	✓	220-240 V~ 50 Hz	20	3856024406857
420-213	16W	crna/black	160 m³/h	120 mm	34 db	2000 rpm	IPX4	-	220-240 V~ 50 Hz	24	3856024406888
420-214	16W	crna/black	160 m³/h	120 mm	34 db	2000 rpm	IPX4	✓	220-240 V~ 50 Hz	24	3856024406895
420-223	18W	crna/black	240 m³/h	150 mm	35 db	1850 rpm	IPX4	-	220-240 V~ 50 Hz	16	3856024406925
420-224	18W	crna/black	240 m³/h	150 mm	35 db	1850 rpm	IPX4	✓	220-240 V~ 50 Hz	16	3856024406932

Automatski osigurači i FID sklopke

Commel automatski osigurači i FID sklopke namijenjeni su ugradnji u kućanstva ali i za industrijsku upotrebu. Visoka proizvodna tehnologija i stroga kontrola kvalitete jamče pouzdanost ovih proizvoda u opasnim situacijama.

RCCB & Miniature Circuit Breaker

Commel circuit breakers and RCCBs are intended for installation in households but also for industrial use. High production technology and strict quality control guarantee the reliability of these products in dangerous situations.



FID SKLOPKA
RCCB



Šifra / Art. No.	Nazivna struja / Rated current	Polovi / Poles	Struja kratkog spoja / Rated short circuit current	Osetljivost / Rated sensitivity	Kom./kutija / Pcs/cin	EAN
470-140	40 A	2	6000A	0,3A	1	3856024401814
470-141	40 A	2	6000A	0,03A	1	3856024404280
470-125	25 A	2	6000A	0,03A	1	3856024401807

Šifra / Art. No.	Nazivna struja / Rated current	Polovi / Poles	Struja kratkog spoja / Rated short circuit current	Osetljivost / Rated sensitivity	Kom./kutija / Pcs/cin	EAN
470-263	63 A	4	6000A	0,03A	1	3856024404501
470-241	40 A	4	6000A	0,03A	1	3856024404297
470-225	25 A	4	6000A	0,03A	1	3856024404273

AUTOMATSKI OSIGURAČI
MINIATURE CIRCUIT BREAKER



Šifra / Art. No.	Nazivna struja / Rated current	Polovi / Poles	Karakteristika okidanja / Curve code	Nazivna prekidna moć / Breaking Capacity	Kom./kutija / Pcs/cin	EAN
465-132	32 A	1	B	6000A	12	3856024401791
465-125	25 A	1	B	6000A	12	3856024401784
465-120	20 A	1	B	6000A	12	3856024401777
465-116	16 A	1	B	6000A	12	3856024401760
465-113	13 A	1	B	6000A	12	3856024406956
465-110	10 A	1	B	6000A	12	3856024401753
465-106	6 A	1	B	6000A	12	3856024401746
465-240	40 A	1	C	6000A	12	3856024404228
465-232	32 A	1	C	6000A	12	3856024404211
465-225	25 A	1	C	6000A	12	3856024404204
465-220	20 A	1	C	6000A	12	3856024404198
465-216	16 A	1	C	6000A	12	3856024404181
465-213	13 A	1	C	6000A	12	3856024406963
465-210	10 A	1	C	6000A	12	3856024404174



Šifra / Art. No.	Nazivna struja / Rated current	Polovi / Poles	Karakteristika okidanja / Curve code	Nazivna prekidna moć / Breaking capacity	Kom./kutija / Pcs/cin	EAN
465-286	32 A	3	C	6000A	4	3856024404266
465-285	25 A	3	C	6000A	4	3856024404259
465-284	20 A	3	C	6000A	4	3856024404242
465-283	16 A	3	C	6000A	4	3856024404235

Kućni prekidači i utičnice

Commel nadžbukne instalacijske sklopke i utičnice ističu se vrhunskom kvalitetom izrade i modernim dizajnom u atraktivnoj antracit boji. Zahvaljujući IP55 stupnju zaštite pogodne su za ugradnju u vrlo vlažne prostore ili na otvorenom. Inovativni sistem bez vijaka omogućava iznimno brzu montažu i sigurno zatvaranje kućišta proizvoda. Gumirane uvodnice za kabel nalaze se s gornje, donje i stražnje strane kućišta.

Home switches and sockets

Commel surface installation switches and sockets stand out for their outstanding manufacturing quality and modern design in an attractive anthracite color. Thanks to the IP55 grade, they are suitable for installation in very humid areas or outdoors. The innovative system without screws enables extremely fast assembly and safe closing of the product housing. Rubberized cable glands are located on the top, bottom and back of the housing.



IP55 Stupanj zaštite
IP55 Grade



Stezaljka bez vijaka omogućava brzo ožičenje prekidača
Screwless wire terminal for quick connection.

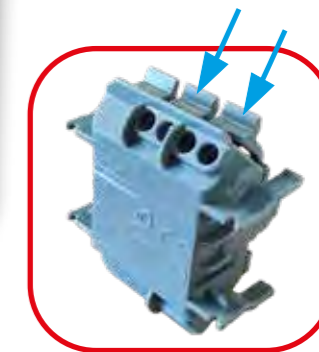

Rotirajuće bravice za brzo otvaranje bez vijaka.
Rotating locks for quick housing opening.

Gumene uvodnice na stražnjoj i bočnim stranama
Rubber cable glands on the top, bottom and back of the housing.

Šifra / Art. No.	Naziv / Type	Boja / Color	Maks. opterećenje / Max. load	Nazivni napon / Voltage	Stupanj zaštite / IP Grade	Kom. /kutija / Pcs/ctn	EAN
043-101	Jednopolna instalacijska sklopka / Surface 1 gang 1 way switch	antracit / anthracite	10 A	250 V~	IP55	10	3856024406277
043-102	Izmjenična instalacijska sklopka / Surface 1 gang 2 way switch	antracit / anthracite	10 A	250 V~	IP55	10	3856024406284



Rotirajuće bravice za brzo otvaranje bez vijaka.
Rotating locks for quick housing opening.

IP55 Stupanj zaštite
IP55 Grade

Stezaljka bez vijaka omogućava brzo ožičenje prekidača
Screwless wire terminal for quick connection.



Gumene uvodnice na stražnjoj i bočnim stranama
Rubber cable glands on the top, bottom and back of the housing.

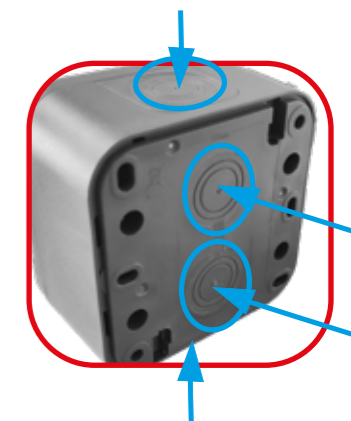

Šifra / Art. No.	Naziv / Type	Boja / Color	Maks. opterećenje / Max. load	Nazivni napon / Voltage	Stupanj zaštite / IP Grade	Kom. /kutija / Pcs/ctn	EAN
043-105	Serijska instalacijska sklopka / Surface 2 gang 1 way switch	antracit / anthracite	10 A	250 V~	IP55	10	3856024406291

Stezaljka bez vijaka omogućava brzo ožičenje prekidača
Screwless wire terminal for quick connection.

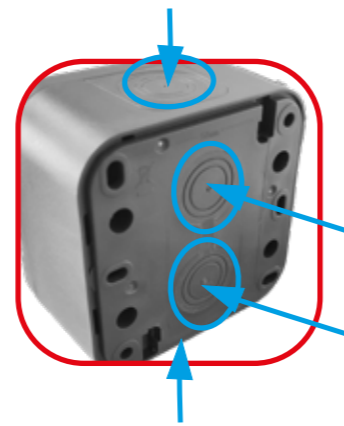
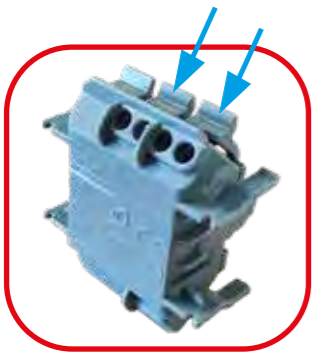

Gumene uvodnice na stražnjoj i bočnim stranama
Rubber cable glands on the top, bottom and back of the housing.

IP55 Stupanj zaštite
IP55 Grade

Rotirajuće bravice za brzo otvaranje bez vijaka.
Rotating locks for quick housing opening.

Šifra / Art. No.	Naziv / Type	Boja / Color	Maks. opterećenje / Max. load	Nazivni napon / Voltage	Stupanj zaštite / IP Grade	Kom./kutija / Pcs/ctn	EAN
043-106	Tipkalo s indikacijom / Surface Push switch with light	antracit / anthracite	10 A	250 V~	IP55	10	3856024406949



Rotirajuće bravice za brzo otvaranje bez vijaka.
Rotating locks for quick opening.

IP55 Stupanj zaštite
IP55 Grade

"Klik" mehanizam poklopca
"Click" lid mechanism

Šifra / Art. No.	Naziv / Type	Boja / Color	Maks. opterećenje / Max. load	Nazivni napon / Voltage	Stupanj zaštite / IP Grade	Kom./kutija / Pcs/ctn	EAN
043-112	Dvopolna utičnica - dvostruka / Surface Schuko double socket	antracit / anthracite	10 A	250 V~	IP55	5	3856024406314

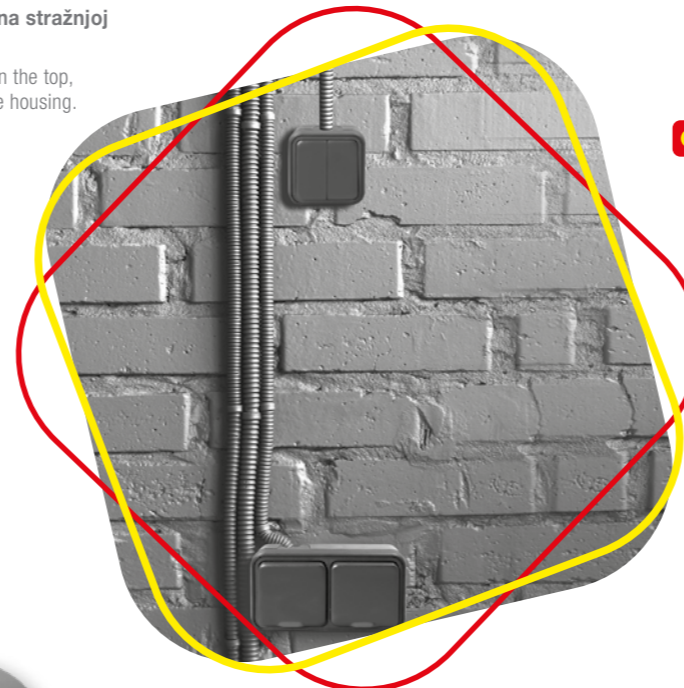

"Klik" mehanizam poklopca
"Click" lid mechanism



Gumirani prsten
Rubber ring

IP55 Stupanj zaštite
IP55 Grade

Rotirajuće bravice za brzo otvaranje bez vijaka.
Rotating locks for quick housing opening.



Šifra / Art. No.	Naziv / Type	Boja / Color	Maks. opterećenje / Max. load	Nazivni napon / Voltage	Stupanj zaštite / IP Grade	Kom./kutija / Pcs/ctn	EAN
043-111	Dvopolna utičnica/ Surface Schuko socket	antracit / anthracite	10 A	250 V~	IP55	10	3856024406307

IP55 Stupanj zaštite
IP55 Grade

Rotirajuće bravice za brzo otvaranje bez vijaka.
Rotating locks for quick opening.

"Klik" mehanizam poklopca
"Click" lid mechanism



Šifra / Art. No.	Naziv / Type	Boja / Color	Maks. opterećenje / Max. load	Nazivni napon / Voltage	Stupanj zaštite / IP Grade	Kom./kutija / Pcs/ctn	EAN
043-113	Dvopolna utičnica + sklopka / Surface Schuko socket+ switch	antracit / anthracite	16 A / 10 A	250 V~	IP55	5	3856024406321

Commel®

Montažni pribor

Proizvodi za pričvršćivanje ili organizaciju kabela neizostavni su kod većine električarskih radova. Commel nudi široki asortiman montažnog pribora namijenjenog hoby majstorima, ali i onog za profesionalnu upotrebu.



Mounting Accessories

Products for cable management are indispensable when doing electrical work. Commel offers a wide range of mounting accessories intended for hobby handymen, but also for professional users.

KABELSKE VEZICE CABLE TIES

Šifra / Art. No.	Promjer / Diameter	Dužina / Length	Boja / Color	Kom./pak / Pcs/pkg	Kom./kutija / Pcs/ctn	EAN
365-101	2,5 mm	100 mm	bijela / white	100	20	3858890440003
365-102	2,5 mm	100 mm	crna / black	100	20	3858890440027
365-103	2,5 mm	150 mm	bijela / white	100	20	3858890440041
365-104	2,5 mm	150 mm	crna / black	100	20	3858890440065
365-111	3,5 mm	150 mm	bijela / white	100	20	3858890440089
365-112	3,5 mm	150 mm	crna / black	100	20	3858890440102
365-113	3,5 mm	200 mm	bijela / white	100	20	3858890440126
365-114	3,5 mm	200 mm	crna / black	100	20	3858890440140
365-121	4,7 mm	300 mm	bijela / white	100	20	3858890440164
365-122	4,7 mm	300 mm	crna / black	100	20	3858890440188
365-123	4,7 mm	380 mm	bijela / white	50	20	3858890441147
365-124	4,7 mm	380 mm	crna / black	50	20	3858890441154
365-131	7,5 mm	250 mm	bijela / white	25	20	3858890441161
365-132	7,5 mm	250 mm	crna / black	25	20	3858890441178
365-133	7,5 mm	400 mm	bijela / white	25	20	3858890441185
365-134	7,5 mm	400 mm	crna / black	25	20	3858890441192

Šifra / Art. No.	Promjer / Diameter	Dužina / Length	Boja / Color	Kom./pak / Pcs/pkg	Kom./kutija / Pcs/ctn	EAN
365-115	3,5 mm	200 mm	zelena / green	100	20	3856024404754

Šifra / Art. No.	Promjer / Diameter	Dužina / Length	Boja / Color	Kom./pak / Pcs/pkg	Kom./kutija / Pcs/ctn	EAN
365-175	2,5 mm	150 mm	5 boja / 5 colors	100	20	3856024403252
365-176	3,6 mm	200 mm	5 boja / 5 colors	100	20	3856024403269
365-177	4,8 mm	300 mm	5 boja / 5 colors	100	20	3856024403276

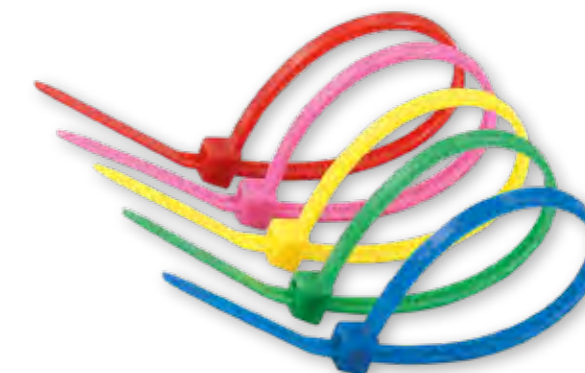

Šifra / Art. No.	Kom./pak / Pcs/pkg	Specifikacija / Specification	Kom./kutija / Pcs/ctn	EAN
365-171	400	2,5 mm x 100 mm bijela / white x 200	25	3858890440201
		2,5 mm x 100 mm crna / black x 100		
		3,5 mm x 200 mm bijela / white x 50		
		3,5 mm x 200 mm crna / black x 50		



Šifra / Art. No.	Kom./pak / Pcs/pkg	Specifikacija / Specification	Kom./kutija / Pcs/ctn	EAN
365-172	300	2,5 mm x 100 mm crvena / red x 25	25	3858890447392
		2,5 mm x 100 mm žuta / yellow x 25		
		2,5 mm x 100 mm crna / black x 25		
		2,5 mm x 100 mm zelena / green x 25		
		2,5 mm x 100 mm bijela / white x 50		
		3,5 mm x 200 mm crvena / red x 50		
		3,5 mm x 200 mm plava / blue x 50		
		3,5 mm x 200 mm bijela / white x 50		



Šifra / Art. No.	Kom./pak / Pcs/pkg	Specifikacija / Specification	Kom./kutija / Pcs/ctn	EAN
365-173	170	2,5 mm x 100 mm x 100	12	3856024401739
		3,5 x 200 mm x 40		
		4,5 mm x 200 mm x 30		



KABELSKE VEZICE S RUPOM ZA PRIČVRŠČIVANJE
MOUNTABLE HEAD CABLE TIES

Šifra / Art. No.	Promjer / Diameter	Dužina / Length	Boja / Color	Kom./pak / Pcs/pkg	Kom./kutija / Pcs/ctn	EAN
365-141	3,6 mm	100 mm	bijela / white	100	20	3856024403009
365-142	3,6 mm	100 mm	crna / black	100	20	3856024403016
365-143	3,6 mm	145 mm	bijela / white	100	20	3856024403023
365-144	3,6 mm	145 mm	crna / black	100	20	3856024403030
365-145	4,3 mm	220 mm	bijela / white	100	20	3856024403047
365-146	4,3 mm	220 mm	crna / black	100	20	3856024403054
365-147	7,6 mm	381 mm	bijela / white	25	20	3856024403061
365-148	7,6 mm	381 mm	crna / black	25	20	3856024403078

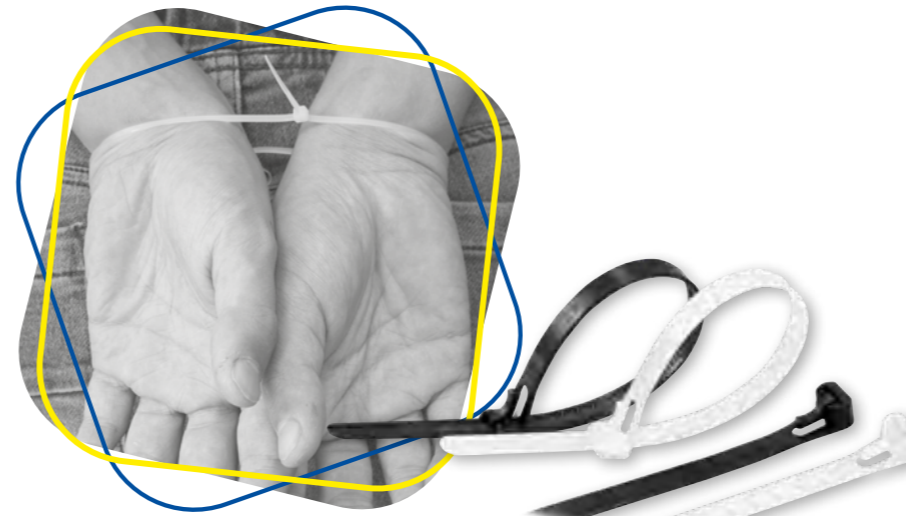

KABELSKE VEZICE ODVEZIVE
RELEASEABLE CABLE TIES

Šifra / Art. No.	Promjer / Diameter	Dužina / Length	Boja / Color	Kom./pak / Pcs/pkg	Kom./kutija / Pcs/ctn	EAN
365-001	7,5 mm	200 mm	bijela / white	25	20	3856024403085
365-002	7,5 mm	200 mm	crna / black	25	20	3856024403092
365-003	7,5 mm	250 mm	bijela / white	25	20	3856024403108
365-004	7,5 mm	250 mm	crna / black	25	20	3856024403115
365-005	7,5 mm	300 mm	bijela / white	25	20	3856024403122
365-006	7,5 mm	300 mm	crna / black	25	20	3856024403139
365-007	7,5 mm	370 mm	bijela / white	25	20	3856024403146
365-008	7,5 mm	370 mm	crna / black	25	20	3856024403153

KABELSKE VEZICE ZA VIŠEKRAATNU
UPOTREBU / KNOT CABLE TIES

Šifra / Art. No.	Dužina / Length	Boja / Color	Kom./pak / Pcs/pkg	Kom./kutija / Pcs/ctn	EAN
365-151	120 mm	bijela / white	100	20	3858890445855
365-152	180 mm	bijela / white	100	20	3858890445862



KABELSKE VEZICE S DVOSTRUKOM OMČOM
DOUBLE LOOP CABLE TIES

Šifra / Art. No.	Promjer / Diameter	Dužina / Length	Boja / Color	Kom./pak / Pcs/pkg	Kom./kutija / Pcs/ctn	EAN
365-051	4,8 mm	200 mm	bijela / white	50	20	3856024403191
365-052	4,8 mm	200 mm	crna / black	50	20	3856024403207

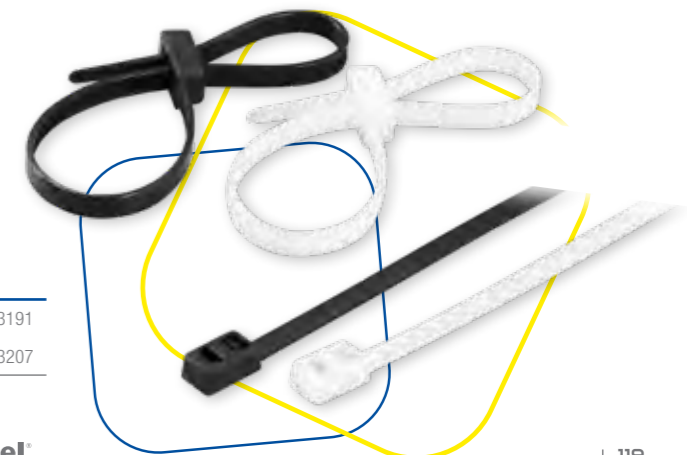

KABELSKE VEZICE, VATROOTPORNE
FLAME RETARDANT CABLE TIES

Šifra / Art. No.	Promjer / Diameter	Dužina / Length	Boja / Color	Kom./pak / Pcs/pkg	Kom./kutija / Pcs/ctn	EAN
365-161	3,6 mm	150 mm	bijela / white	100	20	3856024403160
365-162	3,6 mm	200 mm	bijela / white	100	20	3856024403177
365-163	4,8 mm	300 mm	bijela / white	100	20	3856024403184

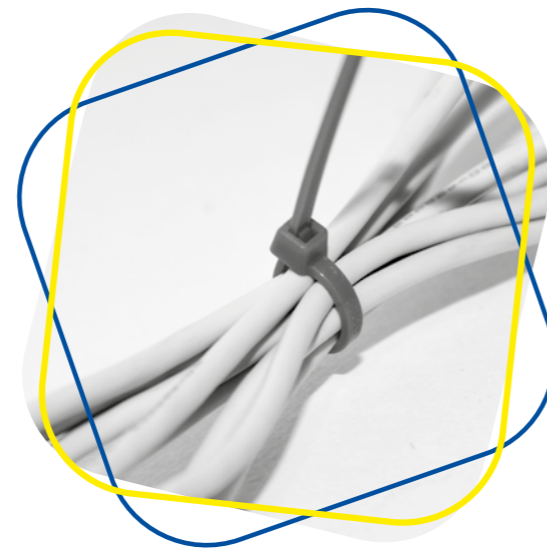

 **Samogasive, u skladu sa standardom UL94-V0**
Fire-retardant, According to standard UL94-V0



METALNE KABELSKE VEZICE
STAINLESS STEEL CABLE TIES

Šifra / Art. No.	Promjer / Diameter	Dužina / Length	Kom./pak / Pcs/pkg	Kom./kutija / Pcs/ctn	EAN
365-181	4,6 mm	200 mm	25	20	3856024403214
365-182	4,6 mm	500 mm	25	20	3856024403221
365-183	7,9 mm	200 mm	25	20	3856024403238
365-184	7,9 mm	500 mm	25	20	3856024403245



KABELSKE VEZICE NA ČIČAK
VELCRO CABLE TIES

Šifra / Art. No.	Promjer / Diameter	Dužina / Length	Boja / Color	Kom./pak / Pcs/pkg	Kom./kutija / Pcs/ctn	EAN
365-191	12 mm	135 mm	crna / black	10	20	3856024403283
365-192	16 mm	210 mm	crna / black	10	20	3856024403290



SAMOLJEPLJIVI DRŽAČI VEZICA
SELF ADHESIVE TIE MOUNTS

Šifra / Art. No.	Dimenzije / Dimensions	Boja / Color	Kom./pak / Pcs/pkg	Kom./kutija / Pcs/ctn	EAN
365-331	20 x 20 mm	bijela / white	25	20	3858890447170
365-332	30 x 30 mm	bijela / white	25	20	3858890447187

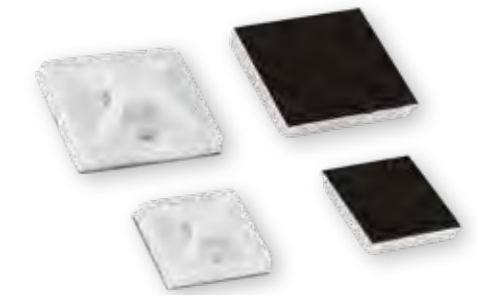

KABELSKE OBUJMICE
CABLE CLIPS

Šifra / Art. No.	Promjer / Diameter	Boja / Color	Kom./pak / Pcs/pkg	Kom./kutija / Pcs/ctn	EAN
365-301	4-7 mm	bijela / white	100	1	3858890440225
365-302	7-10 mm	bijela / white	100	1	3858890440232
365-303	10-14 mm	bijela / white	50	1	3858890440249

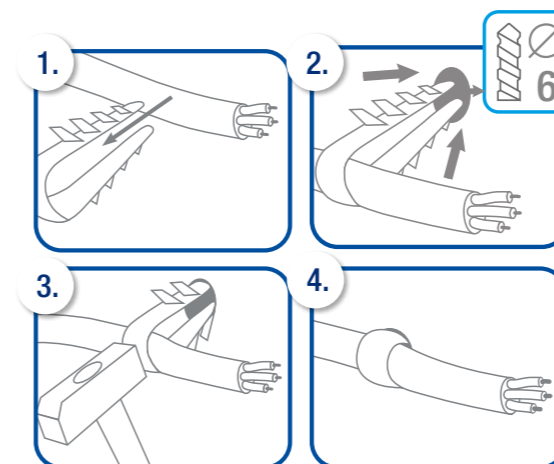

TIPLE OBUJMICE
CABLE FIXING PLUGS

 **Tiple obujmice - omogućavaju čvrsto i kvalitetno pričvršćivanje kabela na zid.**
Cable fixing plug enable firm and high-quality fastening of the cable to the wall.

Šifra / Art. No.	Promjer / Diameter	Boja / Color	Kom./pak / Pcs/pkg	Kom./kutija / Pcs/ctn	EAN
365-311	3-6 mm	bijela / white	15	200	3856024406604
365-312	5-10 mm	bijela / white	15	200	3856024406611
365-313	11-18 mm	bijela / white	10	200	3856024406628



Spojni pribor

Ne pristajemo na kompromise kad je u pitanju kvalitetan i siguran spoj električnih vodiča i kabela, bez obzira radi li se o klasičnim instalacijama u kućanstvu ili upotrebi u zahtjevnijim uvjetima.

Connection Accessories

We do not accept compromises when it comes to a quality and safe connection of electrical wires and cables, regardless of whether we are dealing with a household installation or the one in more demanding conditions.



REDNE STEZALJKE TERMINAL BLOCKS

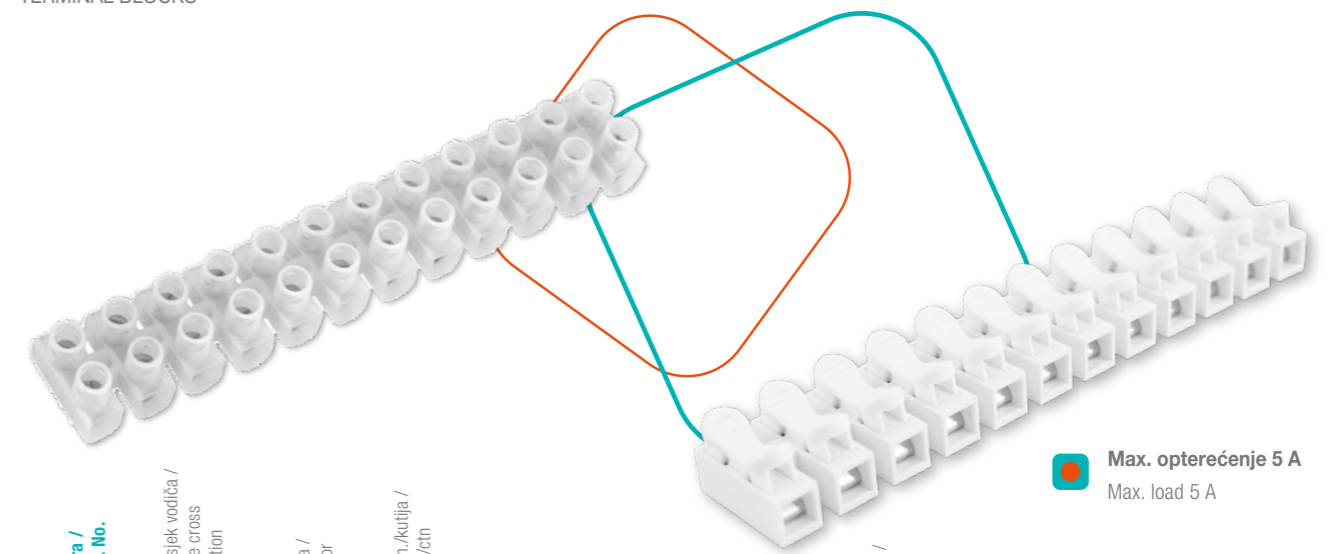

Max. opterećenje 5 A
Max. load 5 A

Šifra / Art. No.	Presjek vodiča / Wire cross section	Boja / Color	Kom./kutija / Pcs/ctn	EAN
365-401	2,5 mm ²	bijela / white	20	3858890440256
365-402	4,0 mm ²	bijela / white	20	3858890440270
365-403	6,0 mm ²	bijela / white	20	3858890440294

Šifra / Art. No.	Presjek vodiča / Wire cross section	Boja / Color	Kom./kutija / Pcs/ctn	EAN
365-409	0,5 - 2,5 mm ²	bijela / white	10	3856024404105

BRZE KABELSKÉ SPOJNICE ZA PUNU ŽICU QUICK WIRE CONNECTORS FOR SOLID WIRE

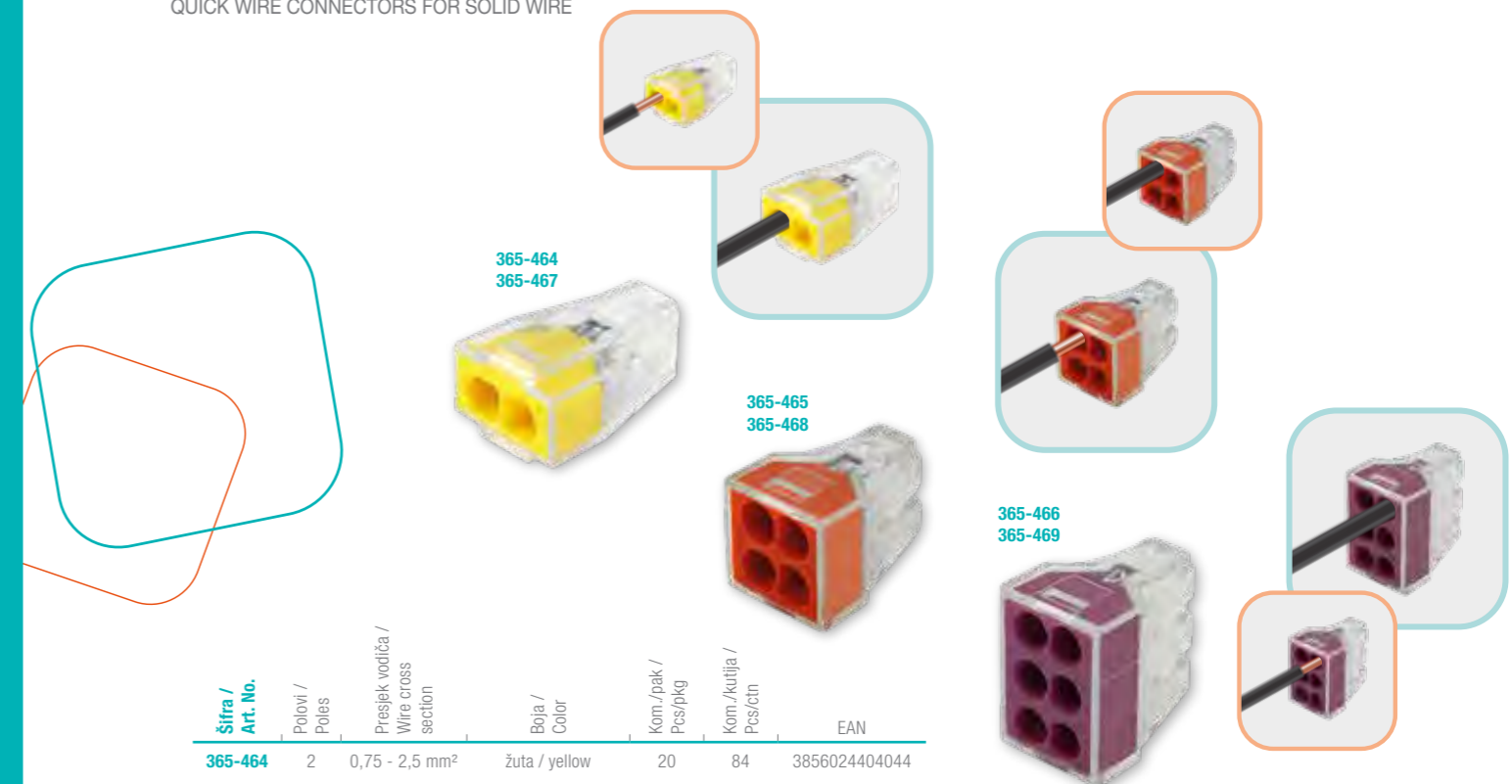

Šifra / Art. No.	Polovi / Poles	Presjek vodiča / Wire cross section	Boja / Color	Kom./pak / Pcs/pkg	Kom./kutija / Pcs/ctn	EAN
365-464	2	0,75 - 2,5 mm ²	žuta / yellow	20	84	3856024404044
365-467	2	0,75 - 2,5 mm ²	žuta / yellow	50	20	3856024404051
365-465	4	0,75 - 2,5 mm ²	narančasta / orange	20	84	3856024404068
365-468	4	0,75 - 2,5 mm ²	narančasta / orange	50	20	3856024404075
365-466	6	0,75 - 2,5 mm ²	ljubičasta / purple	10	84	3856024404082
365-469	6	0,75 - 2,5 mm ²	ljubičasta / purple	50	20	3856024404099

BRZE KABELSKE SPOJNICE
QUICK WIRE CONNECTORS



Šifra / Art. No.	Polovi / Poles	Presjek punog vodica / Solid wire cross section	Presjek fleksibilnog vodica / Stranded wire cross section	Kom./pak / Pcs/pkg	Kom./kutija / Pcs/ctn	EAN
365-450	2	0,2 - 2,5 mm ²	0,2 - 4,0 mm ²	20	84	3858890449341
365-454	2	0,2 - 2,5 mm ²	0,2 - 4,0 mm ²	50	20	3856024404143
365-452	3	0,2 - 2,5 mm ²	0,2 - 4,0 mm ²	10	84	3858890442465
365-455	3	0,2 - 2,5 mm ²	0,2 - 4,0 mm ²	50	20	3856024404150
365-453	5	0,2 - 2,5 mm ²	0,2 - 4,0 mm ²	10	84	3858890442472
365-456	5	0,2 - 2,5 mm ²	0,2 - 4,0 mm ²	50	20	3856024404167

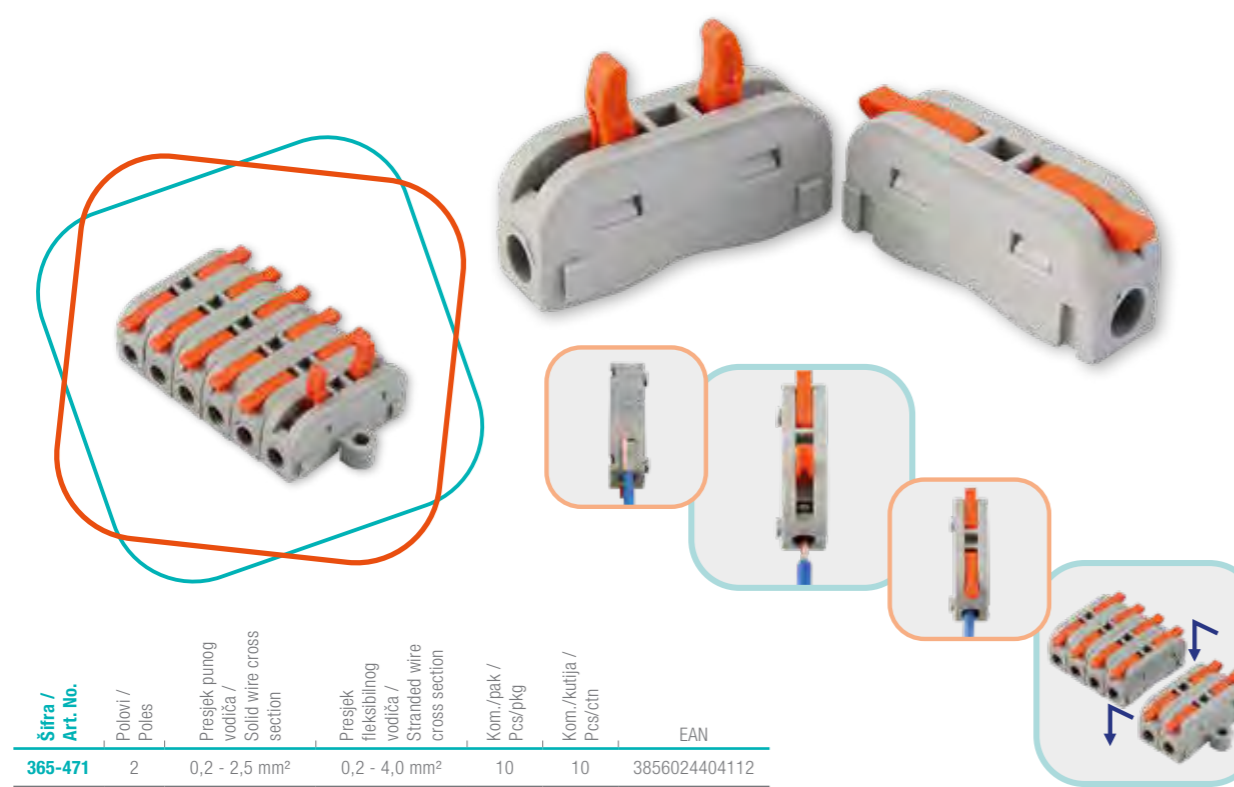

Šifra / Art. No.	Polovi / Poles	Presjek punog vodica / Solid wire cross section	Presjek fleksibilnog vodica / Stranded wire cross section	Kom./pak / Pcs/pkg	Kom./kutija / Pcs/ctn	EAN
365-471	2	0,2 - 2,5 mm ²	0,2 - 4,0 mm ²	10	10	3856024404112

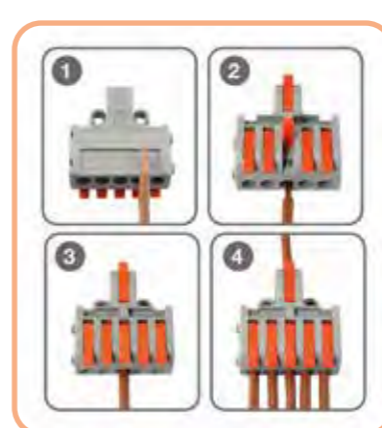
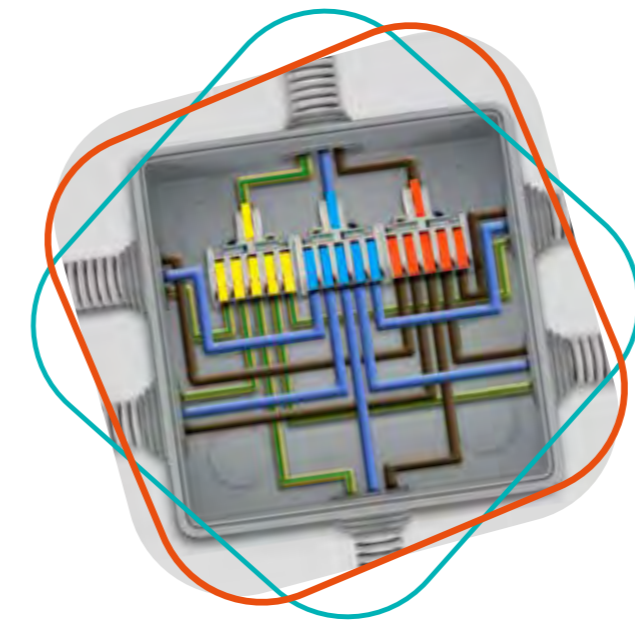

Duljina skinute izolacije
Stripping length indicator



Učvrstite s vijcima
Fastening with screws

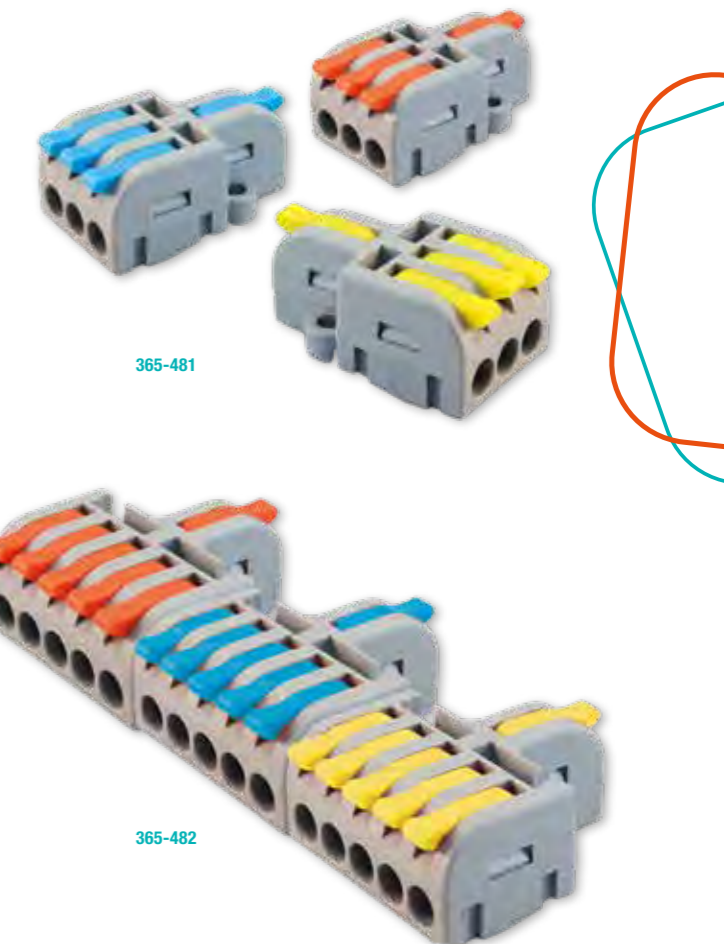

Šifra / Art. No.	Polovi / Poles	Presjek punog vodica / Solid wire cross section	Presjek fleksibilnog vodica / Stranded wire cross section	Kom./pak / Pcs/pkg	Kom./kutija / Pcs/ctn	EAN
365-480	1-2	0,2 - 2,5 mm ²	0,2 - 4,0 mm ²	9	10	3856024405836
365-481	1-3	0,2 - 2,5 mm ²	0,2 - 4,0 mm ²	9	10	3856024405843
365-482	1-5	0,2 - 2,5 mm ²	0,2 - 4,0 mm ²	9	10	3856024405850

BRZE KABELSKE SPOJNICE
QUICK WIRE CONNECTORS

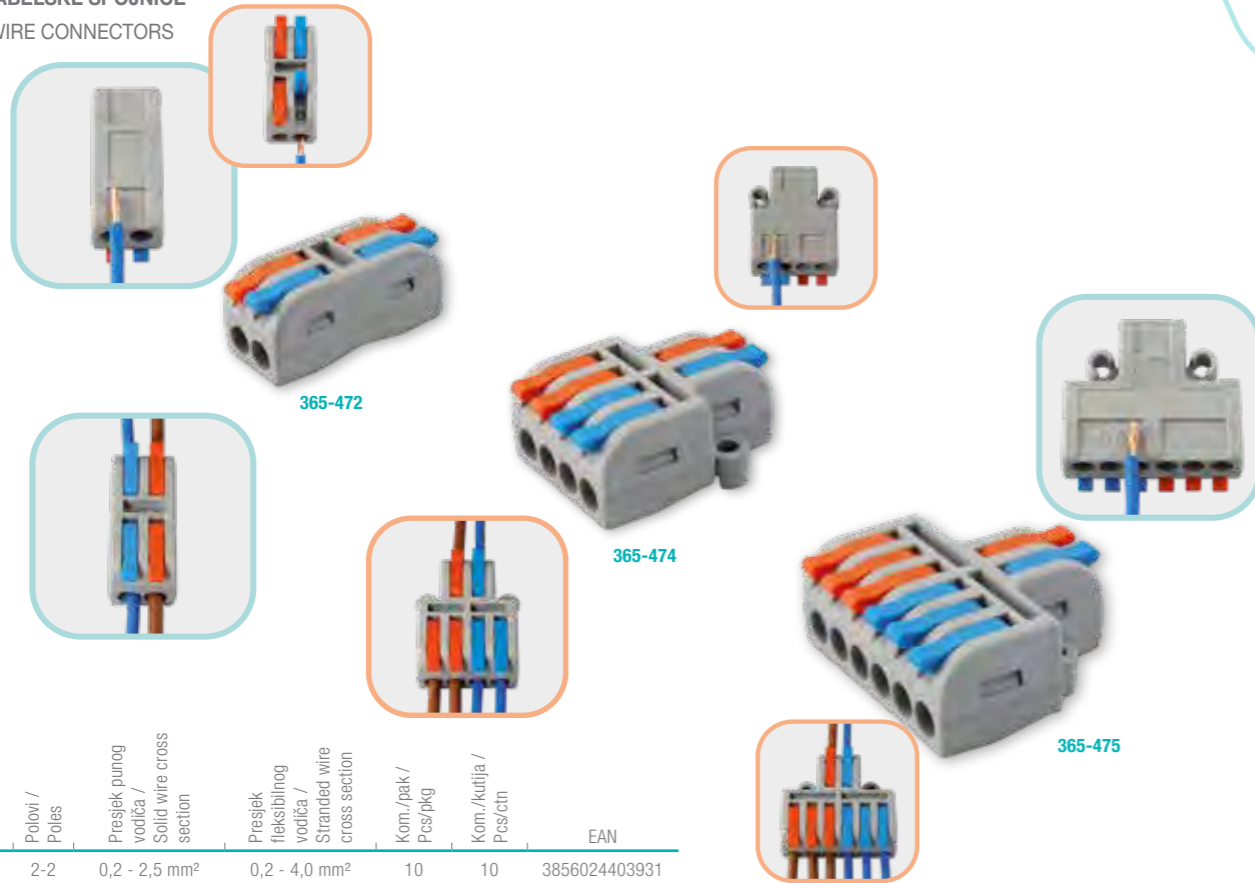

Šifra / Art. No.	Polovi / Poles	Presjek punog vodica / Solid wire cross section	Presjek fleksibilnog vodica / Stranded wire cross section	Kom./pak/ Pcs/pkg	Kom./kutija / Pcs/ctn	EAN
365-472	2-2	0,2 - 2,5 mm ²	0,2 - 4,0 mm ²	10	10	3856024403931
365-474	2-4	0,2 - 2,5 mm ²	0,2 - 4,0 mm ²	5	10	3856024403955
365-475	2-6	0,2 - 2,5 mm ²	0,2 - 4,0 mm ²	5	10	3856024403948

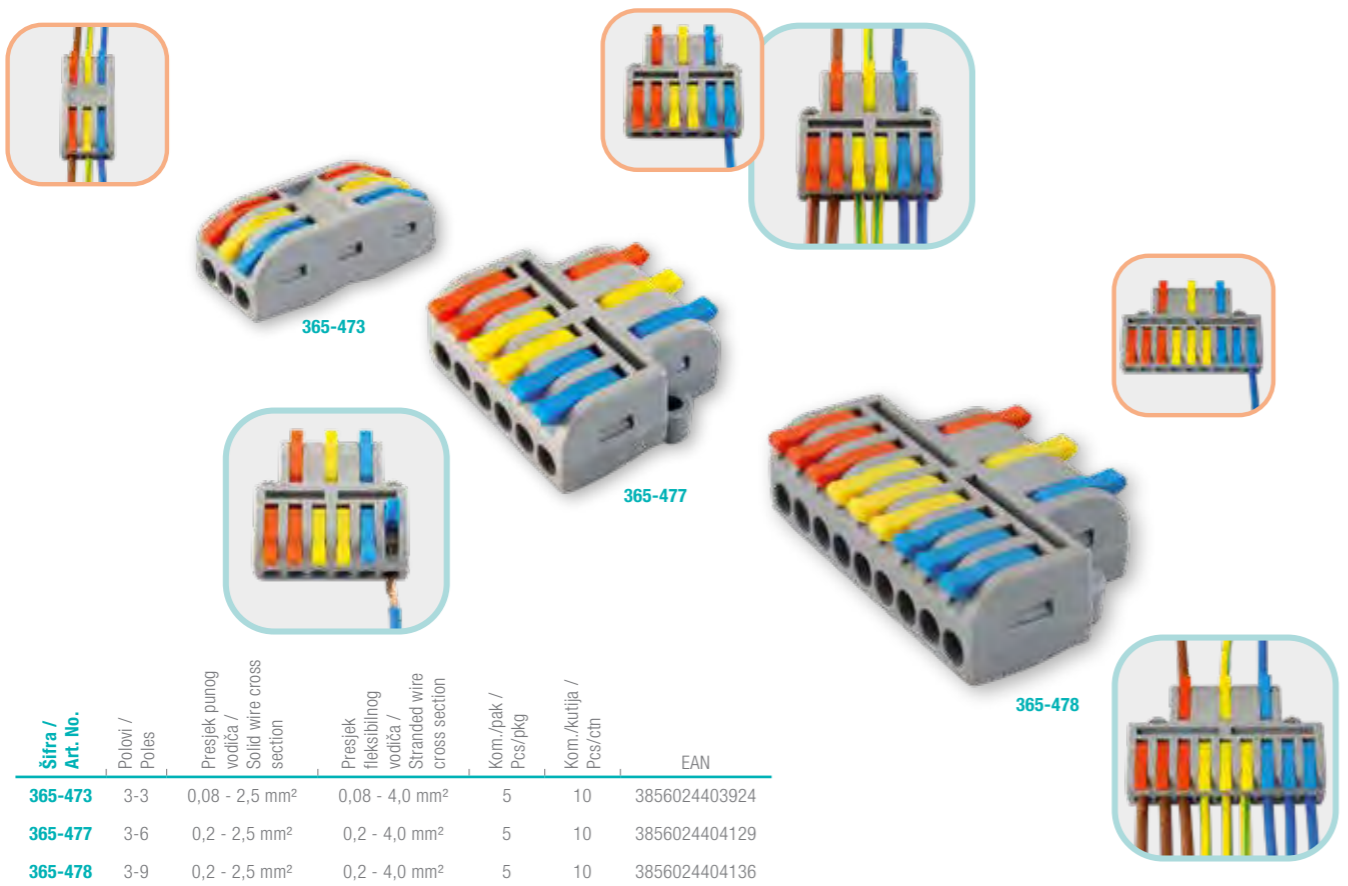

Šifra / Art. No.	Polovi / Poles	Presjek punog vodica / Solid wire cross section	Presjek fleksibilnog vodica / Stranded wire cross section	Kom./pak/ Pcs/pkg	Kom./kutija / Pcs/ctn	EAN
365-473	3-3	0,08 - 2,5 mm ²	0,08 - 4,0 mm ²	5	10	3856024403924
365-477	3-6	0,2 - 2,5 mm ²	0,2 - 4,0 mm ²	5	10	3856024404129
365-478	3-9	0,2 - 2,5 mm ²	0,2 - 4,0 mm ²	5	10	3856024404136

KABELSKI KONEKTORI IP68
CABLE CONNECTOR IP68



 **Mehanizam s brzo spojnicom za montažu bez odvijača**
Quick coupler mechanism for screwless installation

Šifra / Art. No.	Polovi / Poles	Presjek punog vodica / Solid wire cross section	Presjek fleksibilnog vodica / Stranded wire cross section	Stupanj zaštite / IP grade	Dimenzije / Dimensions	Kom./kutija / Pcs/ctn	EAN
365-906	3	0,08 - 2,5 mm ²	0,08 - 4 mm ²	IP68	87 mm x 25 mm	10	3856024404013



 **Rastavljiv, klik mehanizam za montažu bez odvijača**
Reconnectable, Click-on mechanism for screwless installation

Šifra / Art. No.	Polovi / Poles	Presjek vodica / Wire cross section	Stupanj zaštite / IP grade	Dimenzije / Dimensions	Kom./kutija / Pcs/ctn	EAN
365-905	3	0,2 - 1,5 mm ²	IP68	82 mm x 22 mm	10	3856024404020

KABELSKI KONEKTORI IP68
CABLE CONNECTOR IP68



Sifra / Art. No.	Polovi / Poles	Presjek vodiča / Wire cross section	Stupanj zaštite / IP grade	Dimenzije / Dimensions	Kom. /kutija / Pcs./ctn	EAN
365-907	5	1 - 2,5 mm	IP68	80 mm x 85 mm x 25 mm	10	3856024404037

TERMO SKUPLJAJUĆE SPOJNICE S TINOLOM
HEAT SHRINK SOLDERS

Za popravak oštećenih kabela električnog uređaja, spajanje vodiča u automobilu ili u profesionalnom industrijskom okruženju
For repairing a damaged electrical appliance cable, connecting wires in a car or in a professional industrial environment

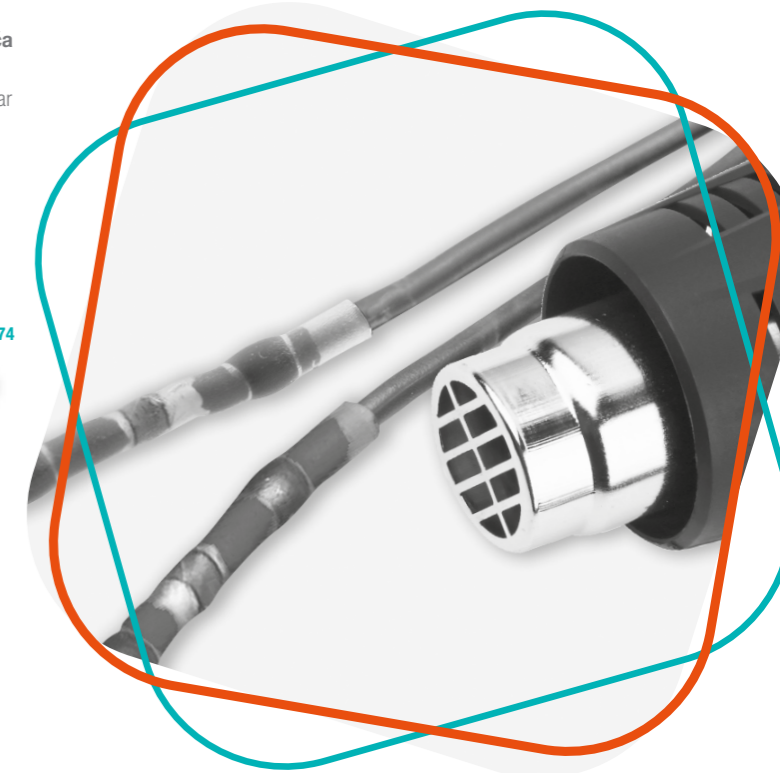

Zalemljen, izoliran i vodootporan spoj u svega nekoliko sekundi
Soldered, insulated and waterproof connection in just a few seconds

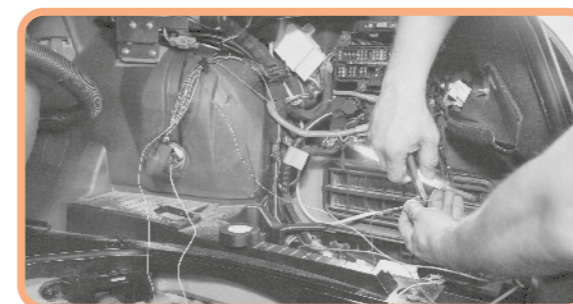
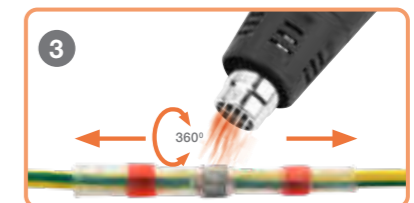

Sifra / Art. No.	Specifikacija / Specifications	Kom. /pak. / Pcs./pkg.	Kom. /kutija / Pcs./ctn.	EAN
365-571	Ø < 0,5 mm ²	20	10	3856024406789
365-572	Ø 0,5 - 1,0 mm ²	20	10	3856024406796
365-573	Ø 1,5 - 2,5 mm ²	20	10	3856024406802
365-574	Ø 4,0 - 6,0 mm ²	20	10	3856024406819

TERMO SKUPLJAJUĆE SPOJNICE S TINOLOM
HEAT SHRINK SOLDERS

Za popravak oštećenih kabela električnog uređaja, spajanje vodiča u automobilu ili u profesionalnom industrijskom okruženju

For repairing a damaged electrical appliance cable, connecting wires in a car or in a professional industrial environment

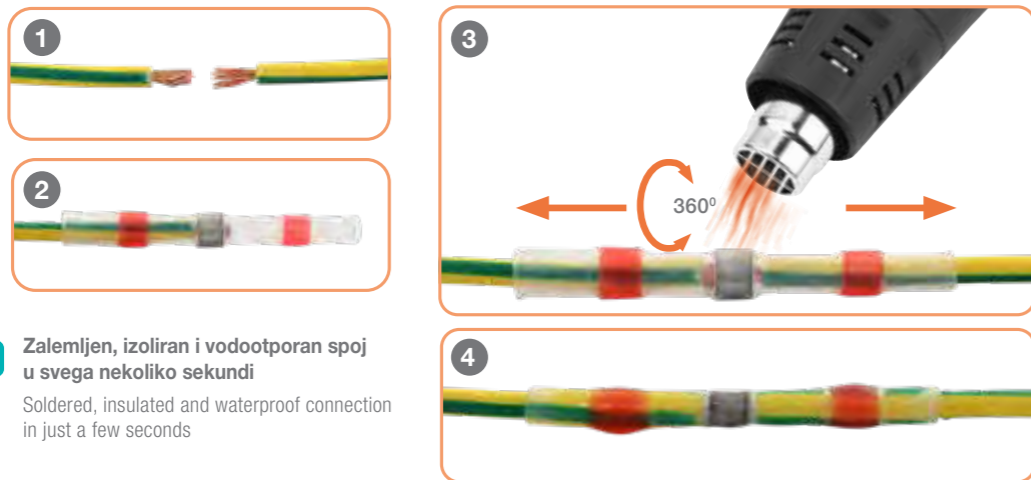
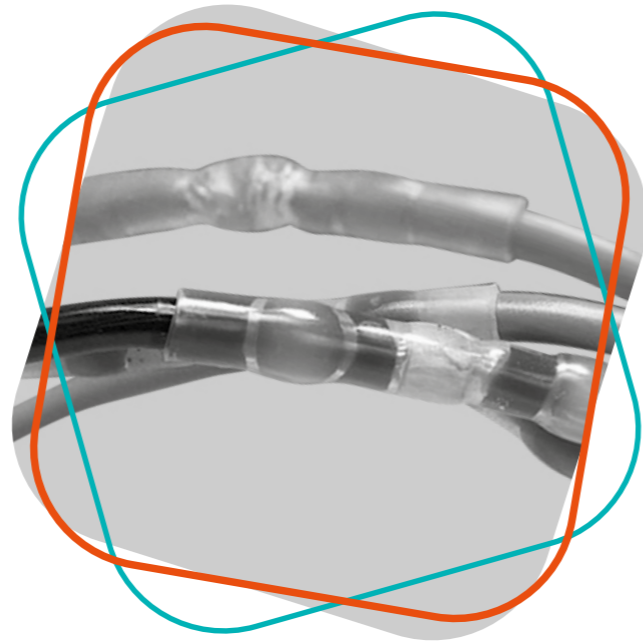

Zalemljen, izoliran i vodootporan spoj u svega nekoliko sekundi
Soldered, insulated and waterproof connection in just a few seconds

Šifra / Art. No.	Specifikacija / Specifications	Kom./pak. / Pcs./pkg.	Kom./kutija / Pcs./ctn.	EAN
365-505	Ø < 0,5 mm ² x 25 Ø 0,5 - 1,0 mm ² x 40 Ø 1,5 - 2,5 mm ² x 25 Ø 4,0 - 6,0 mm ² x 10	100	52	3856024405805

IP68 VODOOTPORNA KUTIJA ZA SPAJANJE KABELA
IP68 WATERPROOF CABLE CONNECTION BOX

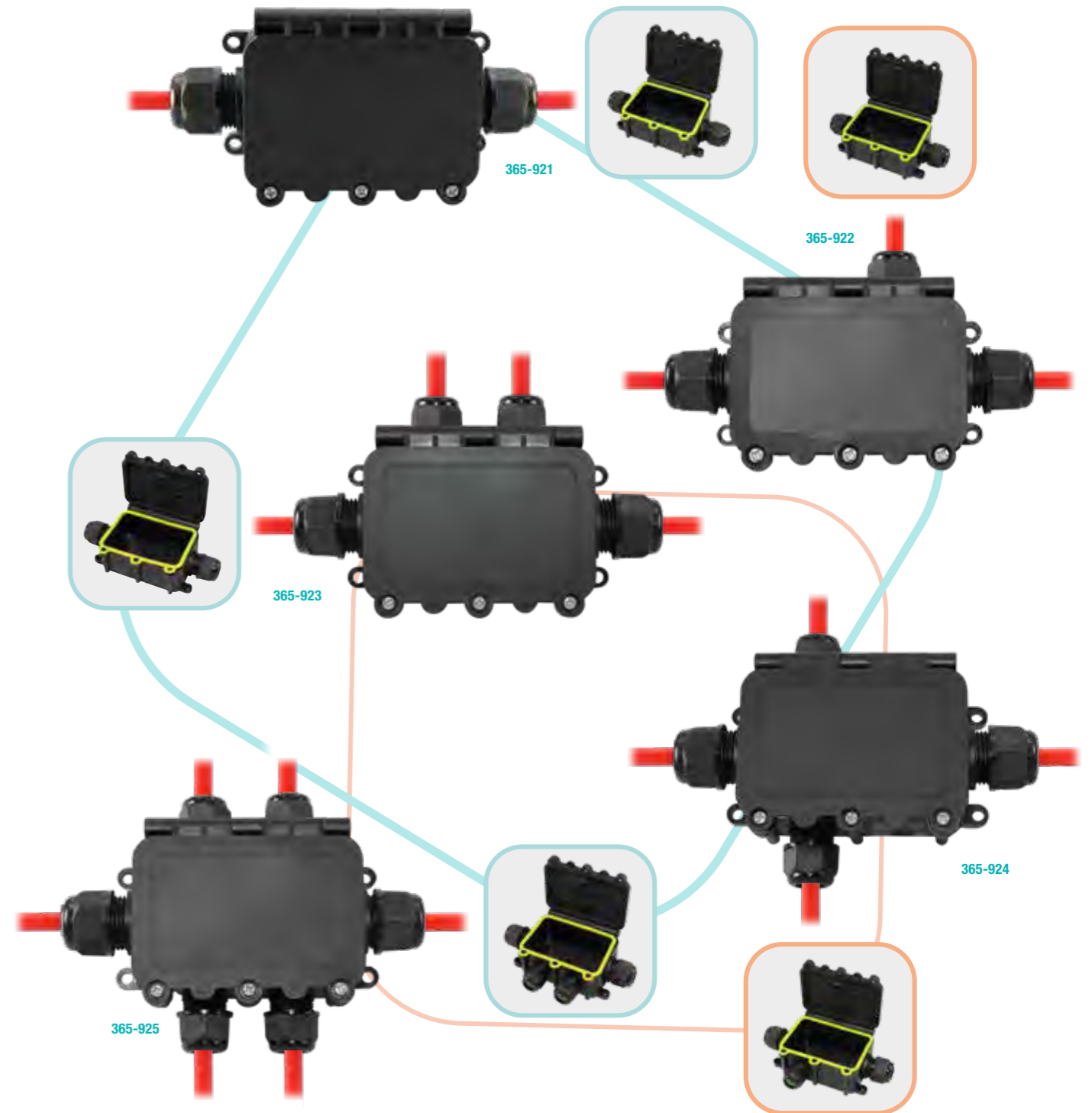

Šifra / Art. No.	Broj ulaznica / Number of cable glands	Stupanj zaštite / IP grade	Dimenzije / Dimensions	Kom./Kutija / Pcs./ctn	EAN
365-921	2	IP68	135 x 70 x 40 mm	10	3856024403962
365-922	3	IP68	135 x 80 x 40 mm	10	3856024403979
365-923	4	IP68	135 x 80 x 40 mm	10	3856024403986
365-924	4	IP68	135 x 100 x 40 mm	10	3856024403993
365-925	6	IP68	135 x 100 x 40 mm	10	3856024404006

Izolacijski pribor

Proizvodi iz ove kategorije pružaju izvrsnu električnu izolaciju, ali i zaštitu električnih spojeva od prašine, vanjskih utjecaja i naprezanja. Izolir trake proizvodimo isključivo od samogasivih materijala.



Insulation Accessories

Products in this category provide excellent electrical insulation, but also protection of electrical connections from dust, external influences and stress. Our insulating tapes are made exclusively from self-extinguishing materials.

TERMO BUŽIRI
HEAT SHRINK TUBINGS



Šifra / Art. No.	Promjer / Diameter	Dužina / Length	Boja / Color	Kom./kutija / Pcs/ctn	EAN
365-561	2,5 → 1,25 mm	1 m	crna / black	1	3858890445909
365-562	3,5 → 1,75 mm	1 m	crna / black	1	3858890445916
365-563	5,0 → 2,5 mm	1 m	crna / black	1	3858890445923
365-564	7,0 → 3,5 mm	1 m	crna / black	1	3858890445930
365-565	10,0 → 5,0 mm	1 m	crna / black	1	3858890445947
365-566	13,0 → 6,5 mm	1 m	crna / black	1	3858890445954

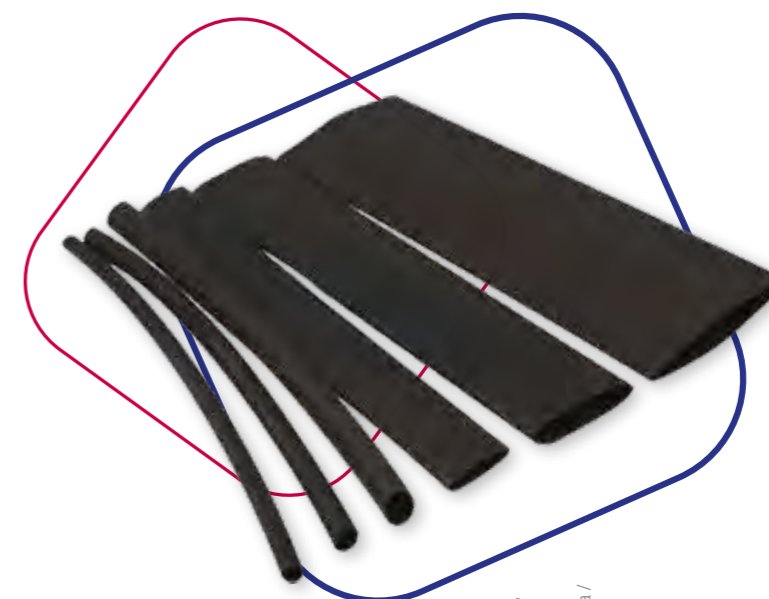

Šifra / Art. No.	Promjer / Diameter	Dužina / Length	Boja / Color	Kom./pak / Pcs/pkg	Kom./kutija / Pcs/ctn	EAN
365-550	1,5 → 0,75 mm	1 m	crna / black	10	10	3856024403498
365-551	2,5 → 1,25 mm	1 m	crna / black	10	10	3858890441758
365-552	3,5 → 1,75 mm	1 m	crna / black	10	10	3858890441772
365-553	5,0 → 2,5 mm	1 m	crna / black	10	10	3858890441796
365-554	7,0 → 3,5 mm	1 m	crna / black	10	10	3858890441819
365-555	10,0 → 5,0 mm	1 m	crna / black	10	10	3858890441833
365-556	13,0 → 6,5 mm	1 m	crna / black	10	10	3858890441857
365-557	20,0 → 10 mm	1 m	crna / black	10	10	3858890441871
365-558	25,0 → 12,5 mm	1 m	crna / black	10	10	3858890441895

TERMO BUŽIRI
HEAT SHRINK TUBINGS

Šifra / Art. No.	Dužina / Length	Specifikacija / Specification	Kom./pak / Pcs/pkg	Kom./kutija / Pcs/ctn	EAN
365-502	10 cm	1,5 mm x 30	100	20	3856024406048
		2,5 mm x 30			
		4,0 mm x 20			
		6,0 mm x 10			
		10,0 mm x 6			
13,0 mm x 4					



Šifra / Art. No.	Dužina / Length	Specifikacija / Specification	Kom./pak / Pcs/pkg	Kom./kutija / Pcs/ctn	EAN
365-501	10 cm	1,5 mm x 30	100	20	3858890440355
		2,5 mm x 30			
		4,0 mm x 20			
		6,0 mm x 10			
		10,0 mm x 6			
		13,0 mm x 4			



IZOLIR TRAKE
INSULATING TAPES

- Samogasive**
Fire retardant
- U skladu sa standardom EN 60454-2**
According to standard EN 60454-2

Boje / Colors



Šifra / Art. No.	Boja / Color	Dužina / Length	Širina / Width	Debljina / Thickness	Kom./kutija / Pcs/ctn	EAN
365-601	crna / black	10 m	15 mm	0,13 mm	10	3858890440379
365-602	plava / blue	10 m	15 mm	0,13 mm	10	3858890440393
365-603	žuto-zelena / yellow-green	10 m	15 mm	0,13 mm	10	3858890440416
365-604	crvena / red	10 m	15 mm	0,13 mm	10	3858890440430
365-605	bijela / white	10 m	15 mm	0,13 mm	10	3858890441314
365-651	crna / black	10 m	19 mm	0,13 mm	10	3858890440454
365-652	plava / blue	10 m	19 mm	0,13 mm	10	3858890440478
365-653	žuto-zelena / yellow-green	10 m	19 mm	0,13 mm	10	3858890440492
365-654	crvena / red	10 m	19 mm	0,13 mm	10	3858890440515
365-655	bijela / white	10 m	19 mm	0,13 mm	10	3858890441338
365-656	zelena / green	10 m	19 mm	0,13 mm	10	3858890449204
365-657	žuta / yellow	10 m	19 mm	0,13 mm	10	3858890449211



Tuljci i stopice

Upotrebom tuljaka i stopica osiguravate čvrst i trajan električni spoj. Commel asortiman tuljaka i stopica sadrži proizvode različitih dimenzija i područja primjene, a isporučuju se u praktičnom blister pakiranju.

Wire Terminals

Wire terminals ensure a strong and lasting electrical connection. The Commel range of wire terminals contains products of various sizes and areas of application, and they come in a practical blister pack.



IZOLIRANI ZAVRŠNI TULJCI INSULATED CORD END TERMINALS



Šifra / Art. No.	Dimenzije / Dimensions	Kom./pak / Pcs/pkg	Kom./kutija / Pcs/ctn	EAN
365-801	0,75 mm ²	100	100	3858890444940
365-802	1,0 mm ²	100	100	3858890444957
365-803	1,5 mm ²	100	100	3858890444964
365-804	2,5 mm ²	100	100	3858890444971

TULJCI I STOPICE | WIRE TERMINALS

NEIZOLIRANI ZAVRŠNI TULJCI NON-INSULATED CORD END TERMINALS



Šifra / Art. No.	Dimenzije / Dimensions	Kom./pak / Pcs/pkg	Kom./kutija / Pcs/ctn	EAN
365-805	0,75 mm ²	100	100	3856024403320
365-806	1,0 mm ²	100	100	3856024403337
365-807	1,5 mm ²	100	100	3856024403344
365-808	2,5 mm ²	100	100	3856024403351

IZOLIRANI ZAVRŠNI TULJCI INSULATED CORD END TERMINALS



Šifra / Art. No.	Specifikacija / Specification	Kom./pak / Pcs/pkg	Kom./kutija / Pcs/ctn	EAN
365-701	0,5 mm ² x 50	400	1	3858890440539
	0,75 mm ² x 100			
	1,0 mm ² x 100			
	1,5 mm ² x 100			
	2,5 mm ² x 50			

IZOLIRANE SPOJNE ČAHURE INSULATED CONNECTORS



Šifra / Art. No.	Dimenzije / Dimensions	Kom./pak / Pcs/pkg	Kom./kutija / Pcs/ctn	EAN
365-891	0,5 - 1,5 mm ²	20	100	3856024403306
365-892	1,5 - 2,5 mm ²	20	100	3856024403313

VILIČASTE STOPICE SPADE TERMINALS

Šifra / Art. No.	Dimenzije / Dimensions	Kom./pak / Pcs/pkg	Kom./kutija / Pcs/ctn	EAN
365-851	0,5 - 1,5 mm ² Ø 4,3 mm	25	100	3858890445077
365-852	1,5 - 2,5 mm ² Ø 5,3 mm	25	100	3858890445084

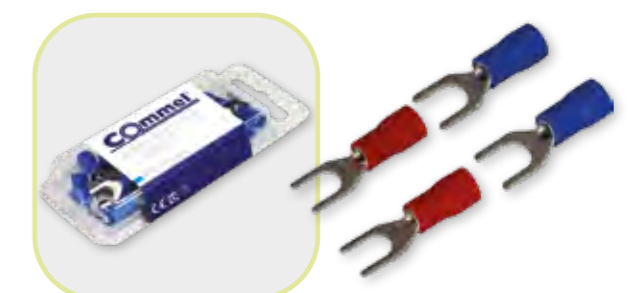

OKRUGLE STOPICE
RING TERMINALS



Šifra / Art. No.	Dimenzije / Dimensions	Kom./pak / Pcs/pkg	Kom./kutija / Pcs/ctn	EAN
365-881	0,5 - 1,5 mm ² Ø 4,3 mm	25	100	3858890445152
365-882	0,5 - 1,5 mm ² Ø 5,3 mm	25	100	3858890445169
365-883	1,5 - 2,5 mm ² Ø 4,3 mm	25	100	3858890445176
365-884	1,5 - 2,5 mm ² Ø 5,3 mm	25	100	3858890445183
365-885	4,0 - 6,0 mm ² Ø 8,4 mm	10	100	3858890445190

UTIKAČI I NATIKAČI ZA ŽICU
WIRE DISCONNECTS



Šifra / Art. No.	Dimenzije / Dimensions	Kom./pak / Pcs/pkg	Kom./kutija / Pcs/ctn	EAN
365-811	0,5 - 1,5 mm ² / 0,8 x 2,8 mm	25	100	3858890445015
365-812	0,5 - 1,5 mm ² / 0,8 x 6,35 mm	25	100	3858890445053
365-813	1,5 - 2,5 mm ² / 0,8 x 4,75 mm	25	100	3858890445039

Šifra / Art. No.	Dimenzije / Dimensions	Kom./pak / Pcs/pkg	Kom./kutija / Pcs/ctn	EAN
365-821	0,5 - 1,5 mm ² / 0,8 x 2,8 mm	25	100	3858890445022
365-822	0,5 - 1,5 mm ² / 0,8 x 6,35 mm	25	100	3858890445060
365-823	1,5 - 2,5 mm ² / 0,8 x 4,75 mm	25	100	3858890445046

Šifra / Art. No.	Dimenzije / Dimensions	Kom./pak / Pcs/pkg	Kom./kutija / Pcs/ctn	EAN
365-831	0,5 - 1,5 mm ² / 0,8 x 4,75 mm	10 + 10	100	3858890444988
365-832	0,5 - 1,5 mm ² / 0,8 x 6,35 mm	10 + 10	100	3858890444995
365-833	1,5 - 2,5 mm ² / 0,8 x 4,75 mm	10 + 10	100	3858890445008

KUTNI UTIKAČI + NATIKAČI ZA ŽICU
MALE + FEMALE WIRE DISCONNECTS



Šifra / Art. No.	Dimenzije / Dimensions	Kom./pak / Pcs/pkg	Kom./kutija / Pcs/ctn	EAN
365-841	0,5 - 1,5 mm ² / 0,8 x 6,35 mm	25 + 25	25	3858890445091
365-842	1,5 - 2,5 mm ² / 0,8 x 6,35 mm	25 + 25	25	3858890445107

IZOLIRANI UTIKAČI I NATIKAČI ZA ŽICU
INSULATED BULLET TERMINALS



Šifra / Art. No.	Dimenzije / Dimensions	Kom./pak / Pcs/pkg	Kom./kutija / Pcs/ctn	EAN
365-861	0,5 - 1,5 mm ² / Ø 4 mm	25	100	3858890445114
365-862	1,5 - 2,5 mm ² / Ø 5 mm	25	100	3858890445121

Šifra / Art. No.	Dimenzije / Dimensions	Kom./pak / Pcs/pkg	Kom./kutija / Pcs/ctn	EAN
365-871	0,5 - 1,5 mm ² / Ø 4 mm	25	25	3858890445138
365-872	1,5 - 2,5 mm ² / Ø 5 mm	25	25	3858890445145

SET STOPICA - 18 VRSTA
WIRE TERMINAL SET - 18 TYPES



Šifra / Art. No.	Kom./pak / Pcs/pkg	Kom./kutija / Pcs/ctn	EAN
365-702	175	1	3858890445961

Električarski alati

Povećajte učinkovitost i uštedite vrijeme upotrebom praktičnih Commel električarskih alata.

Hand Tools

Increase efficiency and save time by using practical Commel hand tools.

Commel®



SET STOPICA S KLIJEŠTIMA
ELECTRICAL PLIERS AND TERMINALS SET

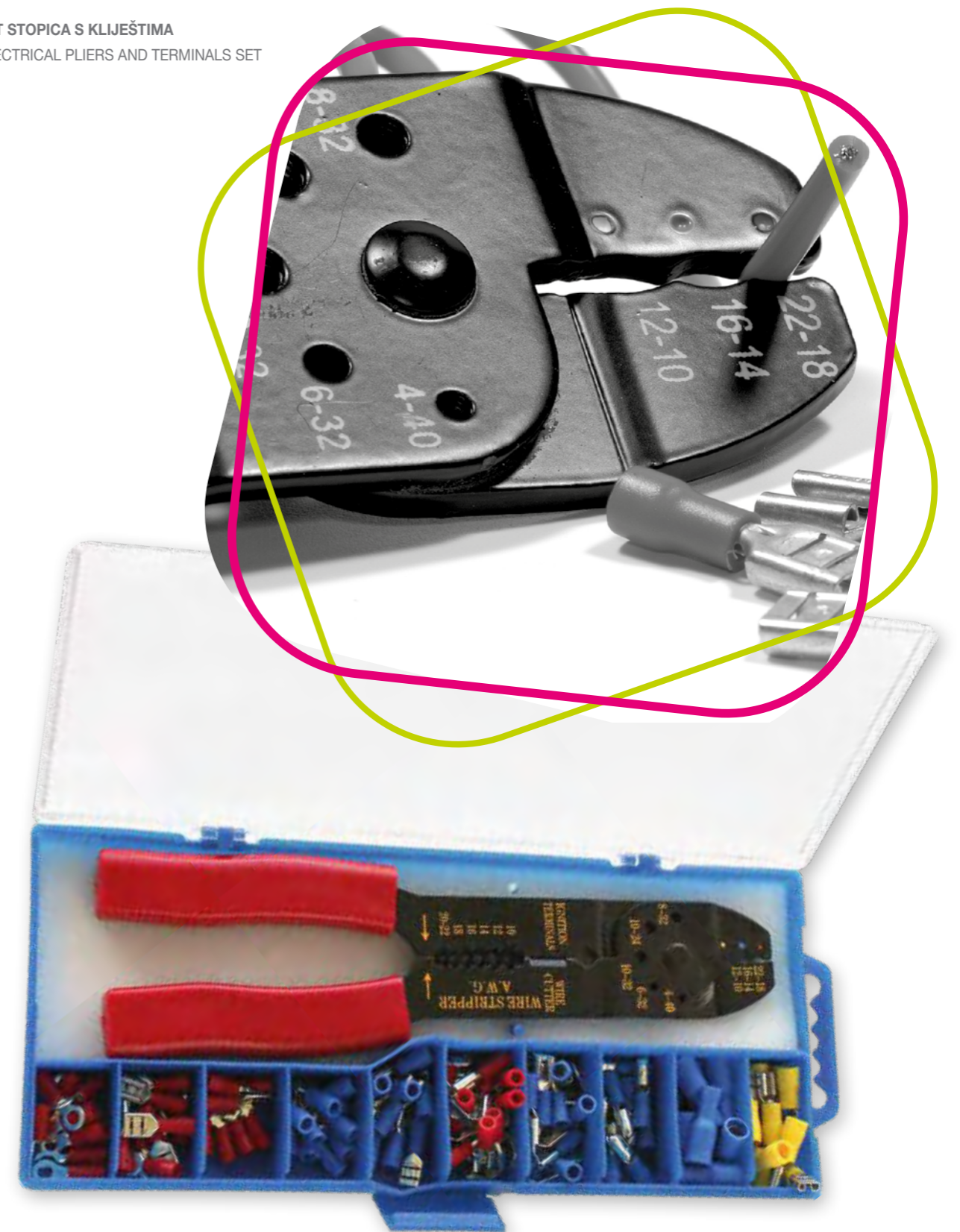

Šifra / Art. No.	Kom./pak / Pcs/pkg	Kom./kutija / Pcs/ctn	EAN
365-751	101	10	3858890442489

SAMOPODESIVA KLIJEŠTA ZA SKIDANJE IZOLACIJE
SELF-ADJUSTING WIRE STRIPPER

Skidanje izolacije
Wire stripping



Rezanje
Cutting



Krimpanje
Crimping



Šifra / Art. No.	Boja / Color	Kom./kutija / Pcs/ctn	EAN
370-101	crveno-crna / red-black	10	3856024403368

Skidanje izolacije
Wire stripping



Rezanje
Cutting



Šifra / Art. No.	Boja / Color	Kom./kutija / Pcs/ctn	EAN
370-102	crveno-crna / red-black	10	3856024403375

ELEKTRIČARSKA KLIJEŠTA
ELECTRICIAN'S PLIERS



370-131



370-132



370-133



370-134



Šifra / Art. No.	Vrsta kliješta / Pliers type	Dužina / Length	Kom./pak / Pcs/pkg	Kom./kutija / Pcs/ctn	EAN
370-131	Kombinirana kliješta / Combination pliers	180 mm	6	48	3856024404716
370-132	Kliješta za bočno sječenje / Diagonal cutter pliers	160 mm	6	60	3856024404723
370-133	Kliješta produžena ravna / Long nose pliers	200 mm	6	60	3856024404730
370-134	Kliješta za skidanje izolacije / Wire stripper pliers	160 mm	6	60	3856024404747

IZOLIRANI ODVIJAČI
INSULATED SCREWDRIVERS

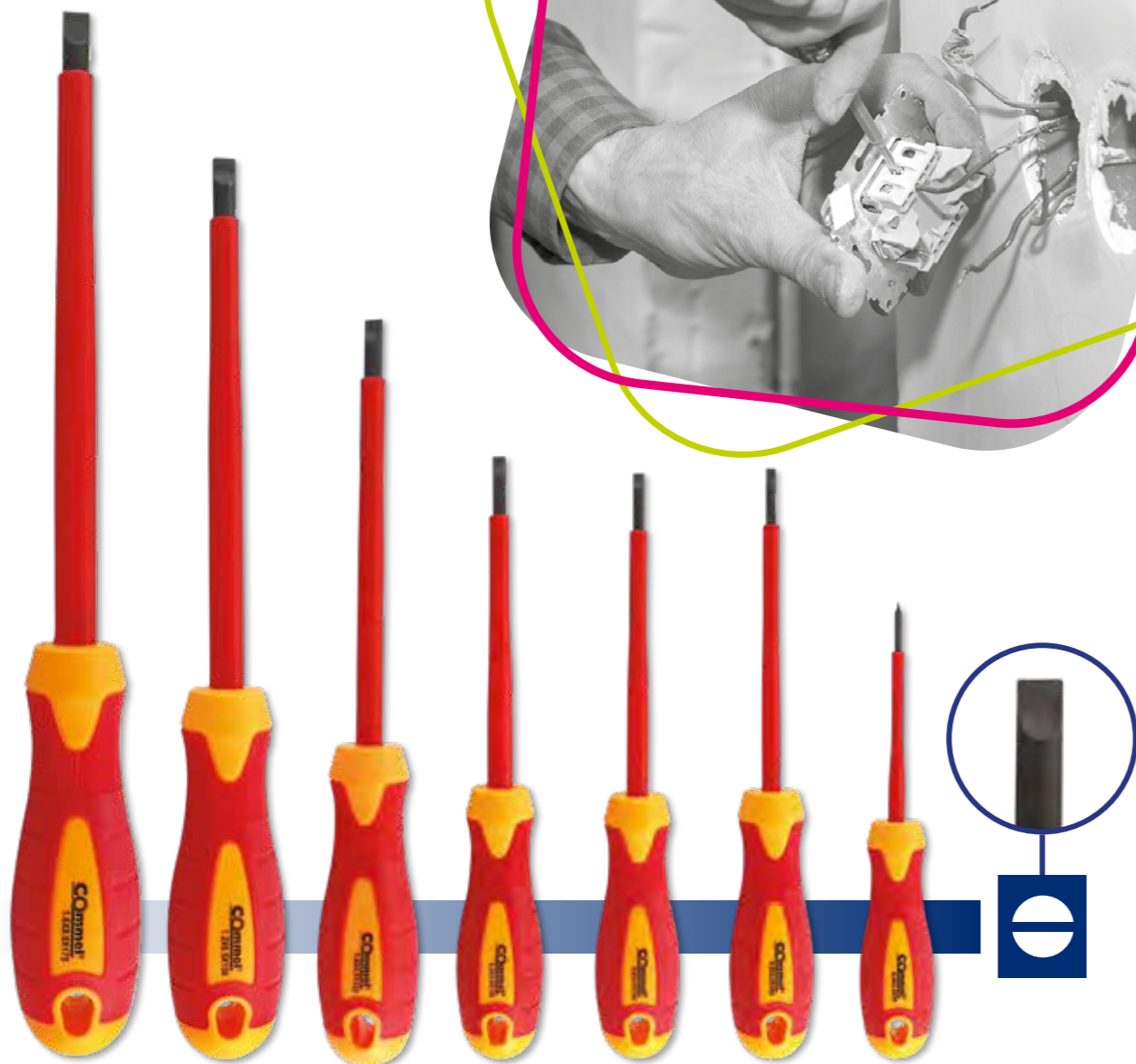
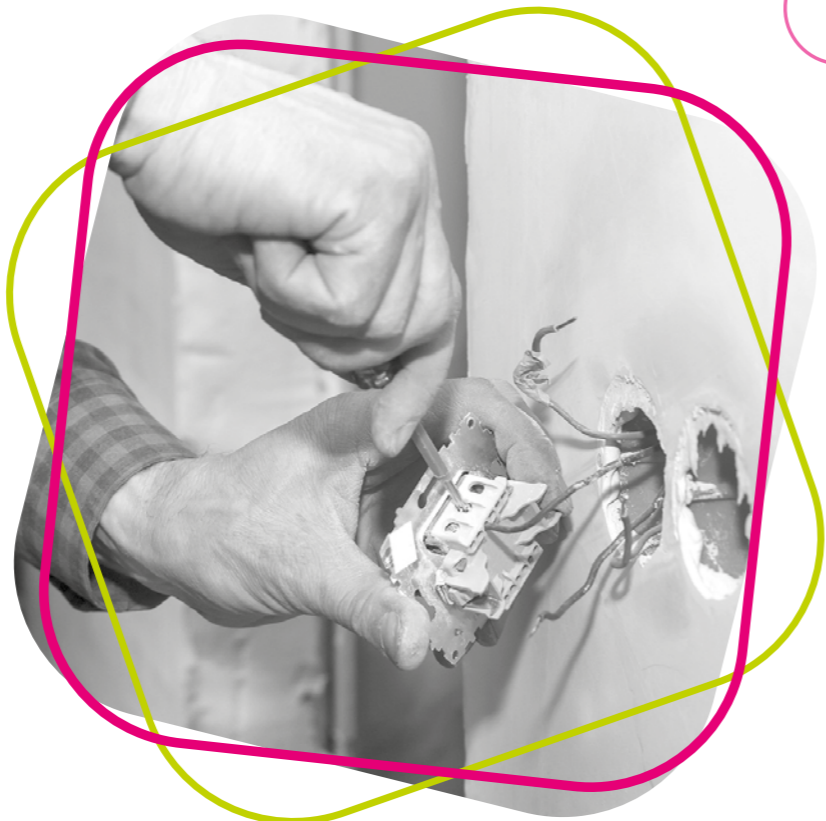

370-207 370-206 370-205 370-204 370-203 370-202 370-201

Šifra / Art. No.	Tip odvijanja / Screwdriver type	Dimenzije / Dimensions	Kom./pak / Pcs/pkg	Kom./kutija / Pcs/ctn	EAN
370-201	ravni / slotted	SL 2.5 x 75 mm	12	240	3856024406444
370-202	ravni / slotted	SL 3 x 100 mm	12	240	3856024406451
370-203	ravni / slotted	SL 3.5 x 100 mm	12	240	3856024406468
370-204	ravni / slotted	SL 4 x 100 mm	12	240	3856024406475
370-205	ravni / slotted	SL 5.5 x 125 mm	12	120	3856024406482
370-206	ravni / slotted	SL 6.5 x 150 mm	12	120	3856024406499
370-207	ravni / slotted	SL 8 x 175 mm	6	96	3856024406505



ERGONOMIC HANDLE



SOFT GRIP



ERGONOMIC HANDLE



SOFT GRIP

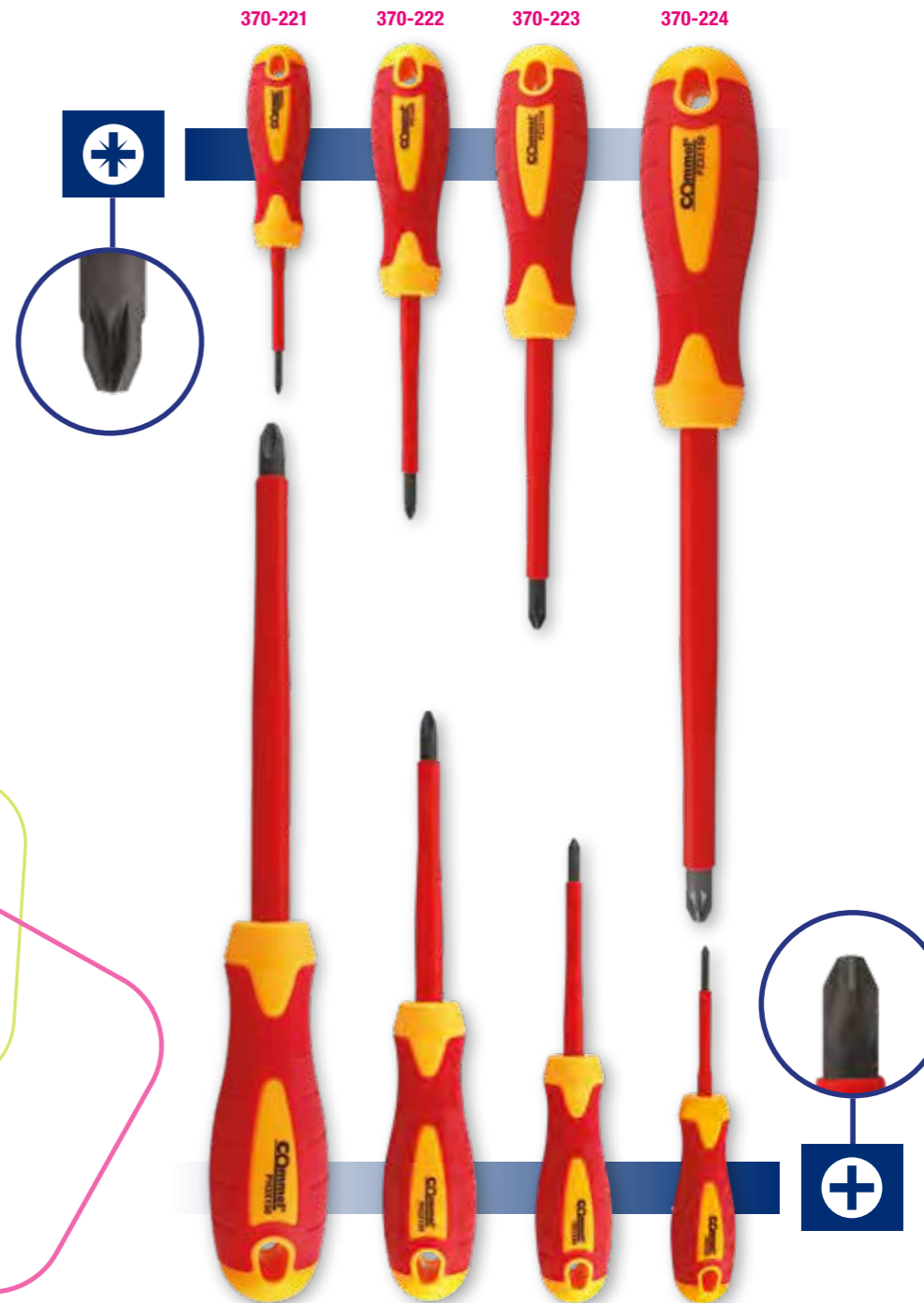

370-214 370-213 370-212 370-211

Šifra / Art. No.	Tip odvijanja / Screwdriver type	Dimenzije / Dimensions	Kom./pak / Pcs/pkg	Kom./kutija / Pcs/ctn	EAN
370-211	križni / phillips	PH0 3 x 60 mm	12	240	3856024406512
370-212	križni / phillips	PH1 5 x 80 mm	12	120	3856024406529
370-213	križni / phillips	PH2 6 x 100 mm	12	120	3856024406536
370-214	križni / phillips	PH3 8 x 150 mm	6	96	3856024406543
370-221	pozidriv / pozidriv	PZ0 3 x 60 mm	12	240	3856024406550
370-222	pozidriv / pozidriv	PZ1 5 x 80 mm	12	120	3856024406567
370-223	pozidriv / pozidriv	PZ2 6 x 100 mm	12	120	3856024406574
370-224	pozidriv / pozidriv	PZ3 8 x 150 mm	6	96	3856024406581

SET VDE ODVIJAČA
VDE SCREWDRIVER SET



Šifra / Art. No.	Tip odvijanja / Screwdriver type	Dimenzije / Dimensions	Kom./pak / Pcs/pkg	Kom./kutija / Pcs/ctn	EAN
370-251	ravni, križni / slotted, phillips	SL 2,5 x 75 mm SL 4,0 x 100 mm SL 5,5 x 125 mm PH0 3 x 60 mm PH1 5 x 80 mm PH2 6 x 100 mm	6	24	3856024406598



ERGONOMIC
HANDLE



SOFT GRIP

NAJLONSKA SAJLA ZA UVLAČENJE KABELA
NYLON FISH TAPE



Šifra / Art. No.	Boja / Color	Vrsta materijala / Type of Material	Dužina / Length	Promjer / Diameter	Kom./kutija / Pcs/ctn	EAN
370-301	plava / blue	najlon / nylon	5 m	3 mm	5	3856024403665
370-302	plava / blue	najlon / nylon	10 m	3 mm	5	3856024403672
370-303	plava / blue	najlon / nylon	20 m	3 mm	5	3856024403689
370-305	plava / blue	najlon / nylon	5 m	4 mm	5	3856024404655
370-306	plava / blue	najlon / nylon	10 m	4 mm	5	3856024404662
370-307	plava / blue	najlon / nylon	20 m	4 mm	5	3856024404679

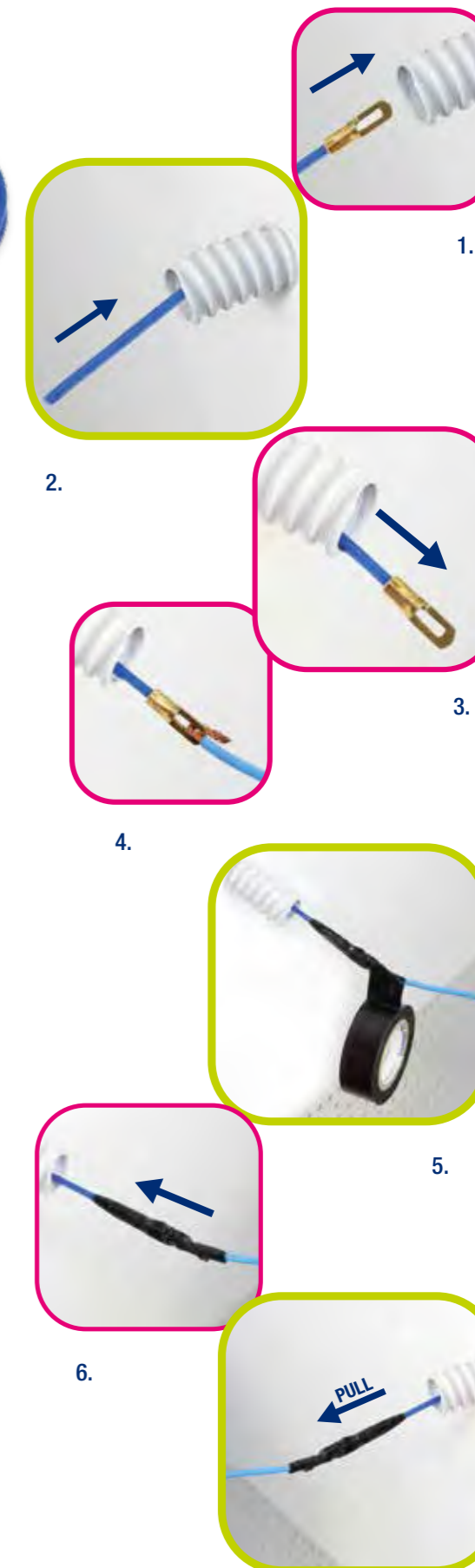

ČELIČNA SAJLA ZA UVLAČENJE KABELA
STEEL FISH TAPE



Šifra / Art. No.	Boja / Color	Vrsta materijala / Type of Material	Dužina / Length	Promjer / Diameter	Kom./kutija / Pcs/ctn	EAN
370-311	crna / black	čelik / steel	5 m	3 mm	5	3856024403696
370-312	crna / black	čelik / steel	10 m	3 mm	5	3856024403702
370-313	crna / black	čelik / steel	20 m	3 mm	5	3856024403719
370-315	crna / black	čelik / steel	5 m	4 mm	5	3856024404686
370-316	crna / black	čelik / steel	10 m	4 mm	5	3856024404693
370-317	crna / black	čelik / steel	20 m	4 mm	5	3856024404709

LED žarulje

Upotrebom LED žarulja ostvaruje se ušteda energije čak do 85% u odnosu na klasične žarulje sa žarnom niti. Životni vijek od 25.000 radnih sati omogućava dugogodišnje korištenje bez potrebe za učestalom izmjenom žarulja, pa je iz tog razloga LED rasvjeta ekološki najprihvatljiviji način osvjetljenja.

Prednosti u odnosu na fluorescentne štedne žarulje su smanjena potrošnja električne energije, duži životni vijek i otpornost na učestalo uključivanje i isključivanje.

LED žarulje ne sadrže otrovne tvari (živu, olovo, plinove,...), ne emitiraju štetna UV i IR zračenja, a omogućuju stabilno osvjetljenje bez treperenja i zujanja.

LED Bulbs

Compared to traditional incandescents, LED bulbs can achieve energy savings of up to 85%. The life span of 25,000 hours allows long-term use without the need for frequent bulb replacement, and for that reason LED lighting is the most environmentally acceptable way of illumination.

The advantages of LED bulbs over CFL bulbs are lower power consumption, longer lifespan and resistance to damage caused by turning on and off repeatedly.

LEDs do not contain toxic materials(mercury, lead, gases,...), they do not emit harmful UV and infrared radiation, and yet they provide stable illumination without flickering or buzzing.

Commel®

Let's
save
energy!



E27/A55

Šifra / Art. No.	Snaga / Power	Svjetlosni tok / Luminous flux	Temperatura svjetla / Color temperature	Indeks uzvrata boje / CRI	Životni vijek / Lifespan	Nazivni napon / Input voltage	Baza / Base	Kom./kutija / Pcs/ctn	EAN	
305-711	4,9 W	470 lm	3000 K	RA >80	15.000 h	220-240 V~	E27	10	3856024404808	F A G
305-811	4,9 W	470 lm	4000 K	RA >80	15.000 h	220-240 V~	E27	10	3856024404815	F A G
305-911	4,9 W	470 lm	6500 K	RA >80	15.000 h	220-240 V~	E27	10	3856024404822	F A G

E27/A60

Šifra / Art. No.	Snaga / Power	Svjetlosni tok / Luminous flux	Temperatura svjetla / Color temperature	Indeks uzvrata boje / CRI	Životni vijek / Lifespan	Nazivni napon / Input voltage	Baza / Base	Kom./kutija / Pcs/ctn	EAN	
305-712	8,5 W	806 lm	3000 K	RA >80	15.000 h	220-240 V~	E27	10	3856024404839	F A G
305-812	8,5 W	806 lm	4000 K	RA >80	15.000 h	220-240 V~	E27	10	3856024404846	F A G
305-912	8,5 W	806 lm	6500 K	RA >80	15.000 h	220-240 V~	E27	10	3856024404853	F A G
305-713	9,5 W	1055 lm	3000 K	RA >80	15.000 h	220-240 V~	E27	10	3856024404860	F A G
305-813	9,5 W	1055 lm	4000 K	RA >80	15.000 h	220-240 V~	E27	10	3856024404877	F A G
305-913	9,5 W	1055 lm	6500 K	RA >80	15.000 h	220-240 V~	E27	10	3856024404884	F A G
305-714	11 W	1350 lm	3000 K	RA >80	15.000 h	220-240 V~	E27	10	3856024404891	F A G
305-814	11 W	1350 lm	4000 K	RA >80	15.000 h	220-240 V~	E27	10	3856024404907	F A G
305-914	11 W	1350 lm	6500 K	RA >80	15.000 h	220-240 V~	E27	10	3856024404914	F A G
305-715	12 W	1500 lm	3000 K	RA >80	15.000 h	220-240 V~	E27	10	3856024404921	F A G
305-815	12 W	1500 lm	4000 K	RA >80	15.000 h	220-240 V~	E27	10	3856024404938	F A G
305-915	12 W	1500 lm	6500 K	RA >80	15.000 h	220-240 V~	E27	10	3856024404945	F A G

E27/A65

Šifra / Art. No.	Snaga / Power	Svjetlosni tok / Luminous flux	Temperatura svjetla / Color temperature	Indeks uzvratne boje / CRI	Životni vijek / Lifespan	Nazivni napon / Input voltage	Baza / Base	Kom./kutija / Pcs/ctn	EAN
305-716	16 W	1800 lm	3000 K	RA >80	15.000 h	220-240 V~	E27	10	3856024404952
305-816	16 W	1800 lm	4000 K	RA >80	15.000 h	220-240 V~	E27	10	3856024404969
305-916	16 W	1800 lm	6500 K	RA >80	15.000 h	220-240 V~	E27	10	3856024404976
305-717	17 W	2000 lm	3000 K	RA >80	15.000 h	220-240 V~	E27	10	3856024404983
305-817	17 W	2000 lm	4000 K	RA >80	15.000 h	220-240 V~	E27	10	3856024404990
305-917	17 W	2000 lm	6500 K	RA >80	15.000 h	220-240 V~	E27	10	3856024405003

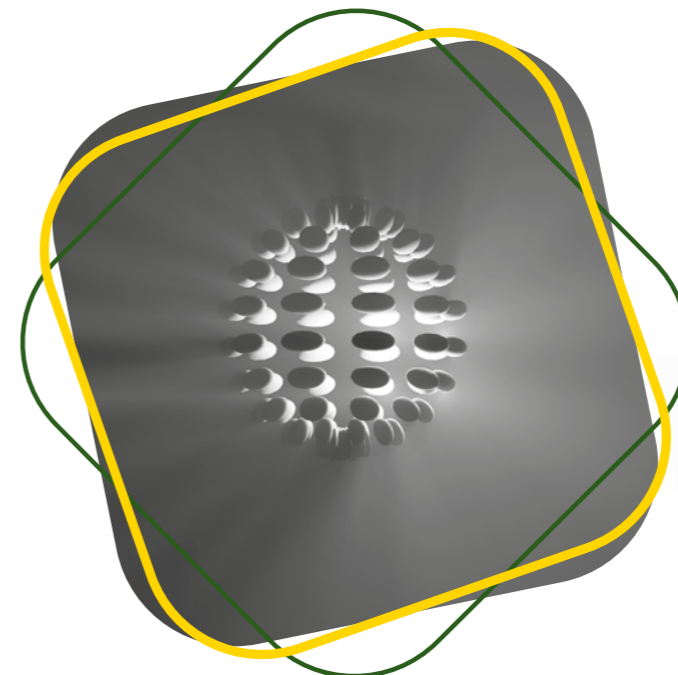

E27/R63

Šifra / Art. No.	Snaga / Power	Svjetlosni tok / Luminous flux	Temperatura svjetla / Color temperature	Indeks uzvratne boje / CRI	Životni vijek / Lifespan	Nazivni napon / Input voltage	Baza / Base	Kom./kutija / Pcs/ctn	EAN
305-745	8 W	806 lm	3000 K	RA >80	15.000 h	220-240 V~	E27	10	3856024405263
305-845	8 W	806 lm	4000 K	RA >80	15.000 h	220-240 V~	E27	10	3856024405270



E27/A80

Šifra / Art. No.	Snaga / Power	Svjetlosni tok / Luminous flux	Temperatura svjetla / Color temperature	Indeks uzvratne boje / CRI	Životni vijek / Lifespan	Nazivni napon / Input voltage	Baza / Base	Kom./kutija / Pcs/ctn	EAN
305-718	20 W	2500 lm	3000 K	RA >80	15.000 h	220-240 V~	E27	5	3856024405010
305-818	20 W	2500 lm	4000 K	RA >80	15.000 h	220-240 V~	E27	5	3856024405027
305-918	20 W	2500 lm	6500 K	RA >80	15.000 h	220-240 V~	E27	5	3856024405034



E27/G45

Šifra / Art. No.	Snaga / Power	Svjetlosni tok / Luminous flux	Temperatura svjetla / Color temperature	Indeks uzvratne boje / CRI	Životni vijek / Lifespan	Nazivni napon / Input voltage	Baza / Base	Kom./kutija / Pcs/ctn	EAN
305-725	3 W	250 lm	3000 K	RA >80	15.000 h	220-240 V~	E27	10	3856024405119
305-825	3 W	250 lm	4000 K	RA >80	15.000 h	220-240 V~	E27	10	3856024405126
305-726	4,9 W	470 lm	3000 K	RA >80	15.000 h	220-240 V~	E27	10	3856024405133
305-826	4,9 W	470 lm	4000 K	RA >80	15.000 h	220-240 V~	E27	10	3856024405140
305-926	4,9 W	470 lm	6500 K	RA >80	15.000 h	220-240 V~	E27	10	3856024405157
305-727	8 W	806 lm	3000 K	RA >80	15.000 h	220-240 V~	E27	10	3856024405164
305-827	8 W	806 lm	4000 K	RA >80	15.000 h	220-240 V~	E27	10	3856024405171



E14/C37

Šifra / Art. No.	Snaga / Power	Svjetlosni tok / Luminous flux	Temperatura svjetla / Color temperature	Indeks uzvratna boje / CRI	Životni vijek / Lifespan	Nazivni napon / Input voltage	Baza / Base	Kom./kutija / Pcs/ctn	EAN
305-731	4,9 W	470 lm	3000 K	RA >80	15.000 h	220-240 V~	E14	10	3856024405188
305-831	4,9 W	470 lm	4000 K	RA >80	15.000 h	220-240 V~	E14	10	3856024405195
305-931	4,9 W	470 lm	6500 K	RA >80	15.000 h	220-240 V~	E14	10	3856024405201
305-732	8 W	806 lm	3000 K	RA >80	15.000 h	220-240 V~	E14	10	3856024405218
305-832	8 W	806 lm	4000 K	RA >80	15.000 h	220-240 V~	E14	10	3856024405225
305-932	8 W	806 lm	6500 K	RA >80	15.000 h	220-240 V~	E14	10	3856024405232



E14/R50

Šifra / Art. No.	Snaga / Power	Svjetlosni tok / Luminous flux	Temperatura svjetla / Color temperature	Indeks uzvratna boje / CRI	Životni vijek / Lifespan	Nazivni napon / Input voltage	Baza / Base	Kom./kutija / Pcs/ctn	EAN
305-741	5 W	470 lm	3000 K	RA >80	15.000 h	220-240 V~	E14	10	3856024405249
305-841	5 W	470 lm	4000 K	RA >80	15.000 h	220-240 V~	E14	10	3856024405256



E14/G45

Šifra / Art. No.	Snaga / Power	Svjetlosni tok / Luminous flux	Temperatura svjetla / Color temperature	Indeks uzvratna boje / CRI	Životni vijek / Lifespan	Nazivni napon / Input voltage	Baza / Base	Kom./kutija / Pcs/ctn	EAN
305-721	3 W	250 lm	3000 K	RA >80	15.000 h	220-240 V~	E14	10	3856024405041
305-821	3 W	250 lm	4000 K	RA >80	15.000 h	220-240 V~	E14	10	3856024405058
305-722	4,9 W	470 lm	3000 K	RA >80	15.000 h	220-240 V~	E14	10	3856024405065
305-822	4,9 W	470 lm	4000 K	RA >80	15.000 h	220-240 V~	E14	10	3856024405072
305-922	4,9 W	470 lm	6500 K	RA >80	15.000 h	220-240 V~	E14	10	3856024405089
305-723	8 W	806 lm	3000 K	RA >80	15.000 h	220-240 V~	E14	10	3856024405096
305-823	8 W	806 lm	4000 K	RA >80	15.000 h	220-240 V~	E14	10	3856024405102



GU10

Šifra / Art. No.	Snaga / Power	Svjetlosni tok / Luminous flux	Temperatura svjetla / Color temperature	Indeks uzvratna boje / CRI	Životni vijek / Lifespan	Nazivni napon / Input voltage	Baza / Base	Kom./kutija / Pcs/ctn	EAN
305-751	3 W	250 lm	3000 K	RA >80	15.000 h	220-240 V~	GU10	10	3856024405287
305-752	4,9 W	470 lm	3000 K	RA >80	15.000 h	220-240 V~	GU10	10	3856024405294
305-852	4,9 W	470 lm	4000 K	RA >80	15.000 h	220-240 V~	GU10	10	3856024405300
305-952	4,9 W	470 lm	6500 K	RA >80	15.000 h	220-240 V~	GU10	10	3856024405317
305-753	7 W	600 lm	3000 K	RA >80	15.000 h	220-240 V~	GU10	10	3856024405324
305-853	7 W	600 lm	4000 K	RA >80	15.000 h	220-240 V~	GU10	10	3856024405331
305-953	7 W	600 lm	6500 K	RA >80	15.000 h	220-240 V~	GU10	10	3856024405348



GU5.3/MR16

Šifra / Art. No.	Snaga / Power	Svjetlosni tok / Luminous flux	Temperatura svjetla / Color temperature	Indeks uzvratna boje / CRI	Životni vijek / Lifespan	Nazivni napon / Input voltage	Baza / Base	Kom./kutija / Pcs/ctn	EAN
305-781	6 W	500 lm	3000 K	RA >80	25.000 h	12 V	GU5.3	10	3856024405423
305-881	6 W	500 lm	4000 K	RA >80	15.000 h	12 V	GU5.3	10	3856024405430



G4

Šifra / Art. No.	Snaga / Power	Svjetlosni tok / Luminous flux	Temperatura svjetla / Color temperature	Indeks uzvratna boje / CRI	Životni vijek / Lifespan	Nazivni napon / Input voltage	Baza / Base	Kom./kutija / Pcs/ctn	EAN
305-771	1,8 W	180 lm	3000 K	RA >80	15.000 h	12 V	G4	20	3856024405416



G9

Šifra / Art. No.	Snaga / Power	Svjetlosni tok / Luminous flux	Temperatura svjetla / Color temperature	Indeks uzvratna boje / CRI	Životni vijek / Lifespan	Nazivni napon / Input voltage	Baza / Base	Kom./kutija / Pcs/ctn	EAN
305-761	3,5 W	315 lm	3000 K	RA >80	15.000 h	220-240 V~	G9	20	3856024405355
305-861	3,5 W	315 lm	4000 K	RA >80	15.000 h	220-240 V~	G9	20	3856024405362



G9

Šifra / Art. No.	Snaga / Power	Svjetlosni tok / Luminous flux	Temperatura svjetla / Color temperature	Indeks uzvratna boje / CRI	Životni vijek / Lifespan	Nazivni napon / Input voltage	Baza / Base	Kom./kutija / Pcs/ctn	EAN
305-762	4,5 W	470 lm	3000 K	RA >80	15.000 h	220-240 V~	G9	20	3856024405379
305-862	4,5 W	470 lm	4000 K	RA >80	15.000 h	220-240 V~	G9	20	3856024405386



G9

Šifra / Art. No.	Snaga / Power	Svjetlosni tok / Luminous flux	Temperatura svjetla / Color temperature	Indeks uzvratna boje / CRI	Životni vijek / Lifespan	Nazivni napon / Input voltage	Baza / Base	Kom./kutija / Pcs/ctn	EAN
305-763	6 W	600 lm	3000 K	RA >80	15.000 h	220-240 V~	G9	20	3856024405393
305-863	6 W	600 lm	4000 K	RA >80	15.000 h	220-240 V~	G9	20	3856024405409



LED trake

LED trake imaju široku primjenu u osvjetljavanju unutarnjih i vanjskih prostora. Koriste se kao primarna rasvjeta u osvjetljavanju kuhinjskih radnih površina, unutrašnjosti ormara ili gazišta stepenica, ali i kao diskretno ambijentalno osvjetljenje montažom u spuštene stropove, iza namještaja, ispod šankova...

LED Strip Lights

LED strips have wide application in indoor and outdoor lighting, from kitchen under cabinet lighting to illumination of stair treads, interiors of closets, but also as indirect ambient light when mounted in dropped ceilings, behind furniture, under a bar...



Šifra / Art. No.	Temperatura svjetla / Color Temperature	Dužina / Length	Broj LED chipova / Number of LED chips	Stupanj zaštite / IP grade	Životni vijek / Lifespan	Napon / Voltage	Daljninski upravljač / Remote control	Kom./kutija / Pcs/cin	EAN
405-203	RGB	3 m	180	IP65	15.000 h	12 V	+	20	3858890440638
405-205	RGB	5 m	300	IP65	15.000 h	12 V	+	20	3858890440652
405-103	6500 K	3 m	180	IP65	15.000 h	12 V	-	20	3858890440577
405-105	6500 K	5 m	300	IP65	15.000 h	12 V	-	20	3858890440591
405-113	3000 K	3 m	180	IP65	15.000 h	12 V	-	20	3858890441598
405-115	3000 K	5 m	300	IP65	15.000 h	12 V	-	20	3858890441581
405-153	3000 K	3 m	90	IP20	15.000 h	12 V	-	20	3858890441567



Šifra / Art. No.	Temperatura svjetla / Color Temperature	Dužina / Length	Snaga / Power	Broj LED chipova / Number of LED chips	Stupanj zaštite / IP grade	Životni vijek / Lifespan	Napon / Voltage	Daljninski upravljač / Remote control	Kom./kutija / Pcs/cin	EAN
405-405	RGB	5 m	24 W	300	IP44	20.000 h	220-240 V~	+	6	3856024402002

Zidne i stropne LED svjetiljke

Prednosti svjetiljki iz ove kategorije su kompaktan dizajn, mogućnost serijskog spajanja, jednostavna i brza montaža te ugrađeni prekidač radi lakšeg rukovanja.

LED Under Cabinet Light Fixtures

The advantages of these light fixtures are compact design, possibility of serial connecting, easy and quick mounting and a built-in switch for easier operation.



- **Mogućnost serijskog spajanja**
 Possibility of serial connection with connector
- **Priključni kabel s utikačem je uključen u pakiranje**
 Connection cable with plug included in the package
- **PC kućište, sa sklopkom**
 PC housing, On/off switch

Šifra / Art. No.	Snaga / Power	Svjetlosni tok svjetiljke / Luminaires luminous flux	Svjetlosni tok izvora svjetlosti / Light source luminous flux	Temperatura svjetla / Color temperature	Indeks uzvratne boje / CRI	Životni vijek / Lifespan	Dimenzije / Dimensions	Stupanj zaštite / IP grade	Nazivni napon / Input voltage	Kom./kutija / Pcs/ctn	EAN
406-205	4 W	400 lm	480 lm	6500 K	RA >80	30.000 h	282 x 21 x 31mm	IP20	220 - 240 V~ 50 Hz	30	3858890448610
406-215	4 W	400 lm	480 lm	4000 K	RA >80	30.000 h	282 x 21 x 31mm	IP20	220 - 240 V~ 50 Hz	30	3858890448658
406-206	7 W	700 lm	840 lm	6500 K	RA >80	30.000 h	582 x 21 x 31mm	IP20	220 - 240 V~ 50 Hz	30	3858890448627
406-216	7 W	700 lm	840 lm	4000 K	RA >80	30.000 h	582 x 21 x 31mm	IP20	220 - 240 V~ 50 Hz	30	3858890448665
406-207	10 W	1000 lm	1200 lm	6500 K	RA >80	30.000 h	882 x 21 x 31mm	IP20	220 - 240 V~ 50 Hz	30	3858890448634
406-217	10 W	1000 lm	1200 lm	4000 K	RA >80	30.000 h	882 x 21 x 31mm	IP20	220 - 240 V~ 50 Hz	30	3858890448672
406-208	14 W	1400 lm	1680 lm	6500 K	RA >80	30.000 h	1182 x 21 x 31 mm	IP20	220 - 240 V~ 50 Hz	30	3858890448641
406-218	14 W	1400 lm	1680 lm	4000 K	RA >80	30.000 h	1182 x 21 x 31 mm	IP20	220 - 240 V~ 50 Hz	30	3858890448689

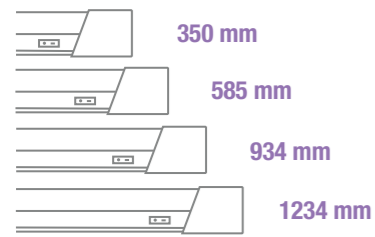

- Slim dizajn
Slim design
- Bez vidljivih kabela
No visible wires

Priključak za instalaciju nalazi se unutar svjetiljke
The wire connector is inside the lamp housing

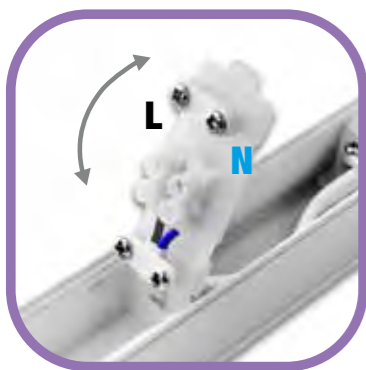

Nosač svjetiljke
Lamp mounting clip



Šifra / Art. No.	Snaga / Power	Svjetlosni tok svjetiljke / Luminaires luminous flux	Temperatura svjetla / Color temperature	Indeks uzvratne boje / CRI	Životni vijek / Lifespan	Dimenzije / Dimensions	Stupanj zaštite / IP grade	Nazivni napon / Input voltage	Kom./kutija / Pcs/cin	EAN
406-221	5 W	1 x 600 lm	4000 K	RA >80	30.000 h	350 x 44 x 29 mm	IP20	220- 240 V~50/60 Hz	20	3856024406376
406-222	10 W	1 x 1200 lm	4000 K	RA >80	30.000 h	585 x 44 x 29 mm	IP20	220- 240 V~50/60 Hz	20	3856024406383
406-223	15 W	1 x 1800 lm	4000 K	RA >80	30.000 h	934 x 44 x 29 mm	IP20	220- 240 V~50/60 Hz	20	3856024406390
406-224	20 W	1 x 2400 lm	4000 K	RA >80	30.000 h	1234 x 44 x 29 mm	IP20	220- 240 V~50/60 Hz	20	3856024406406

MULTIFUNKCIONALNA LED CIJEV
MULTIFUNCTIONAL LED TUBE

Magnetni držač
Magnet holder

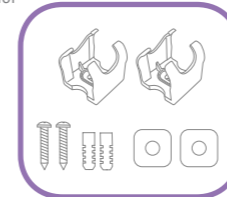

Magnetni držač s rupom za vijak
Magnet clip with mounting hole

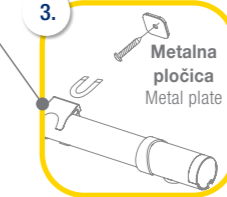
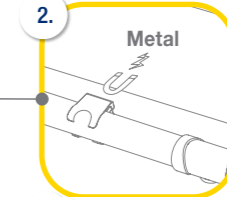
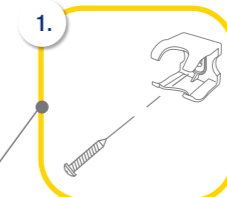

NAČINI MONTAŽE
ATTACHMENT METHODS

- Pričvršćivanje nosača vijcima za ravnu površinu
Fastening the clips with screws to a flat surface
- Pričvršćivanje magnetnog nosača na metalnu površinu
Attaching magnet clips to a flat metal surface
- Pričvršćivanje magnetnog nosača na metalnu pločicu
Attaching magnet clips on a metal plates



ON / OFF prekidač
ON / OFF switch

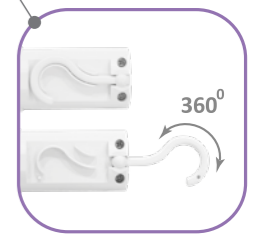

Rotirajuća kuka
Rotating hanger



Šifra / Art. No.	Snaga / Power	Svjetlosni tok svjetiljke / Luminaires luminous flux	Temperatura svjetla / Color temperature	Duljina kabela / Cable length	Dimenzije / Dimensions	Stupanj zaštite / IP grade	Nazivni napon / Input voltage	Kom./kutija / Pcs/cin	EAN
406-601	13 W	1 x 1300 lm	4000 K	1,8 m	900 x 35 x 36 mm	IP20	220- 240 V~50/60 Hz	8	3856024406017



Proizvodi su opremljeni senzorom pokreta kratkog dometa koji ima mogućnost upravljanja radom svjetiljke na jedan od ova dva načina:

- Uključivanje i isključivanje svjetiljke jednostavnim pokretom ruke.
- Kod ugradnje u ormar, uključivanje svjetiljke prilikom otvaranja vrata i isključivanje prilikom zatvaranja vrata.

Način rada se jednostavno podešava na prekidaču koji se nalazi s bočne strane svjetiljke.

The products are equipped with a short-range motion detector which can operate the light fixture in one of these two modes:

- Turns ON and OFF the light fixture when you wave your hand.
- When installed in a cabinet, turns ON the light fixture when door is opened, and turns it OFF when door is closed.

The modes are easily set on the switch located on the side of the lamp.

Detektor pokreta - uključivanje / isključivanje pokretom ruke
Motion detector - turning ON / OFF by hand movement



Mogućnost ugradnje u ormar - automatsko uključivanje prilikom otvaranja vrata
Suitable for installation inside cabinet - turning ON when door is opening

Šifra / Art. No.	Snaga / Power	Svjetlosni tok svjetiljke / Luminaire luminous flux	Svjetlosni tok izvora svjetlosti / Light source luminous flux	Temperatura svjetla / Color temperature	Indeks uzvrata boje / CRI	Životni vijek / Lifespan	Dimenzije / Dimensions	Stupanj zaštite / IP grade	Nazivni napon / Input voltage	Kom./kutija / Pcs/ctn	EAN
406-501	3 W	210 lm	280 lm	4000 K	RA >80	30.000 h	325 x 25 x 14 mm	IP20	100 - 240 V~ 50/60 Hz	20	3858890449969
406-502	5.5 W	400 lm	550 lm	4000 K	RA >80	30.000 h	525 x 25 x 14 mm	IP20	100 - 240 V~ 50/60 Hz	20	3858890449976
406-503	9.5 W	680 lm	920 lm	4000 K	RA >80	30.000 h	940 x 25 x 14 mm	IP20	100 - 240 V~ 50/60 Hz	20	3858890449983

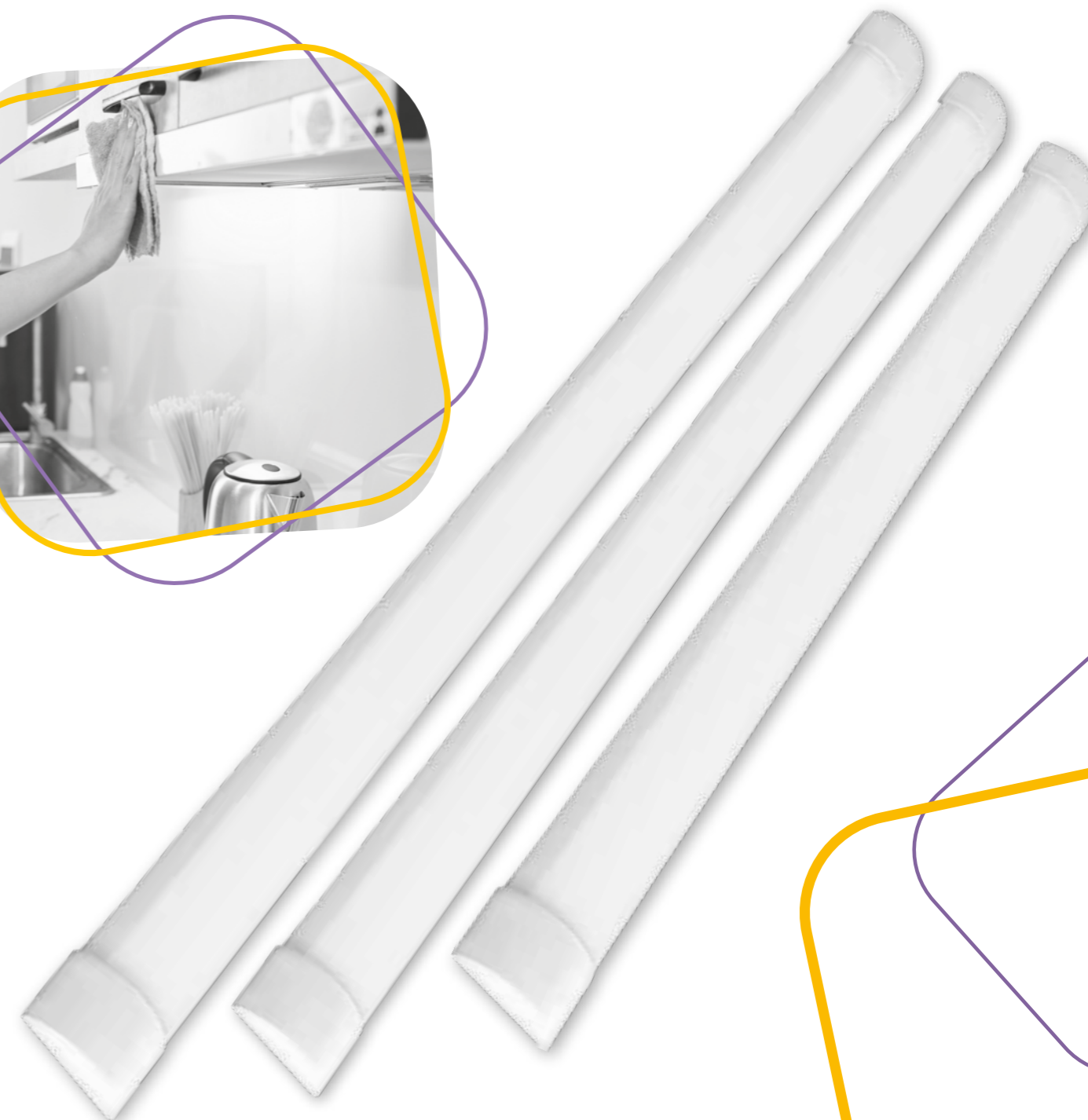

Šifra / Art. No.	Snaga / Power	Svjetlosni tok svjetiljke / Luminaire luminous flux	Svjetlosni tok izvora svjetlosti / Light source luminous flux	Temperatura svjetla / Color temperature	Indeks uzvrata boje / CRI	Životni vijek / Lifespan	Dimenzije / Dimensions	Stupanj zaštite / IP grade	Nazivni napon / Input voltage	Kom./kutija / Pcs/ctn	EAN
406-261	9 W	900 lm	1000 lm	4000 K	RA >80	30.000 h	300 x 25 x 75 mm	IP20	220 - 240 V~ 50/60 Hz	20	3856024402521
406-262	18 W	1800 lm	2200 lm	4000 K	RA >80	30.000 h	600 x 25 x 75 mm	IP20	220 - 240 V~ 50/60 Hz	20	3856024402538
406-263	27 W	2500 lm	3400 lm	4000 K	RA >80	30.000 h	900 x 25 x 75 mm	IP20	220 - 240 V~ 50/60 Hz	20	3856024402545
406-264	36 W	3400 lm	4500 lm	4000 K	RA >80	30.000 h	1200 x 25 x 75 mm	IP20	220 - 240 V~ 50/60 Hz	20	3856024402569



Zidne i stropne svjetiljke

Čvrste i robusne zidne i stropne svjetiljke namijenjene su osvjetljavanju podrumskih, radioničkih, balkonskih i ostalih prostora na kojima je potreba dodatna fizička zaštita stakla. Veći stupanj IP zaštite omogućava njihovu primjenu i u vlažnim prostorima.

Bulkhead Light Fixtures

Solid and robust bulkhead light fixtures are intended for illuminating basements, workshops, balconies and other areas where glass cover needs to be protected. A higher degree of IP protection enables their application also in damp spaces.



Slika / Photo	Šifra / Art. No.	Boja / Color	Grlo / Lamp holder	Max snaga / Max power	Dimenzije / Dimensions	Materijal baze / Base material	Materijal difuzora / Diffuser material	Stupanj zaštite / IP grade	Nazivni napon / Input voltage	Kom./kutija / Pcs/ctn	EAN
1	331-202	siva / gray	E27	40 W	170 x 125 x 115 mm	plastika / plastic	plastika / plastic	IP44	230 V~ 50 Hz	12	3856024405676
2	331-201	siva / gray	E27	60 W	170 x 125 x 115 mm	plastika / plastic	staklo / glass	IP54	230 V~ 50 Hz	12	3856024402286
3	331-205	siva / gray	E27	100 W	195 x 135 x 115 mm	plastika / plastic	staklo / glass	IP44	230 V~ 50 Hz	12	3856024402514
4	331-111	crna / black	E27	60 W	170 x 125 x 115 mm	plastika / plastic	staklo / glass	IP54	230 V~ 50 Hz	12	3856024403726
4	331-112	bijela / white	E27	60 W	170 x 125 x 115 mm	plastika / plastic	staklo / glass	IP54	230 V~ 50 Hz	12	3856024403733
4	331-113	siva / gray	E27	60 W	170 x 125 x 115 mm	plastika / plastic	staklo / glass	IP54	230 V~ 50 Hz	12	3856024403740

Commel®

LED plafonjere

Iako izgledom podsjećaju na klasične plafonjere iz prošlosti, Commel LED plafonjere nemaju ugrađenu klasičnu žarulju već LED modul koji omogućava znatnu uštedu energije i vrlo dugi vijek trajanja. Za zahtjevnije uvjete rada, vlažne prostore tu su i LED plafonjere sa većom IP zaštitom.

LED Ceiling Lamps

Although they look like classic ceiling lamps from the past, Commel LED ceiling lamps do not have built-in light bulbs but LED module that can achieve considerable energy savings and has a long lifespan. For more demanding operating conditions like humid spaces, there are also LED ceiling lamps with higher IP degree of protection.

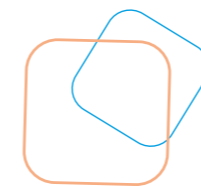
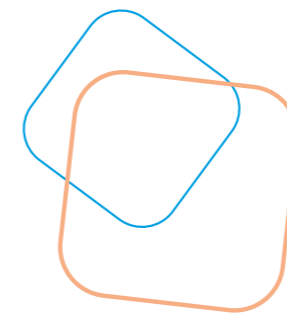

Šifra / Art. No.	Snaga / Power	Svjetlosni tok svjetiljke / Luminaires luminous flux	Svjetlosni tok izvora svjetlosti / Light source luminous flux	Temperatura svjetla / Color temperature	Indeks uzvrata boje / CRI	Životni vijek / Lifespan	Promjer svjetiljke / Lamp diameter	Stupanj zaštite / IP grade	Nazivni napon / Input voltage	Kom./Kutija / Pcs./ctn	EAN
407-125	12 W	840 lm	1200 lm	4000 K	RA >80	25.000 h	260 mm	IP20	220-240 V~ 50/60 Hz	10	3856024403429
407-126	18 W	1260 lm	1850 lm	4000 K	RA >80	25.000 h	330 mm	IP20	220-240 V~ 50/60 Hz	10	3856024403436
407-127	24 W	1680 lm	2500 lm	4000 K	RA >80	25.000 h	380 mm	IP20	220-240 V~ 50/60 Hz	10	3856024403443
407-128	30 W	2240 lm	3150 lm	4000 K	RA >80	25.000 h	380 mm	IP20	220-240 V~ 50/60 Hz	10	3856024403450

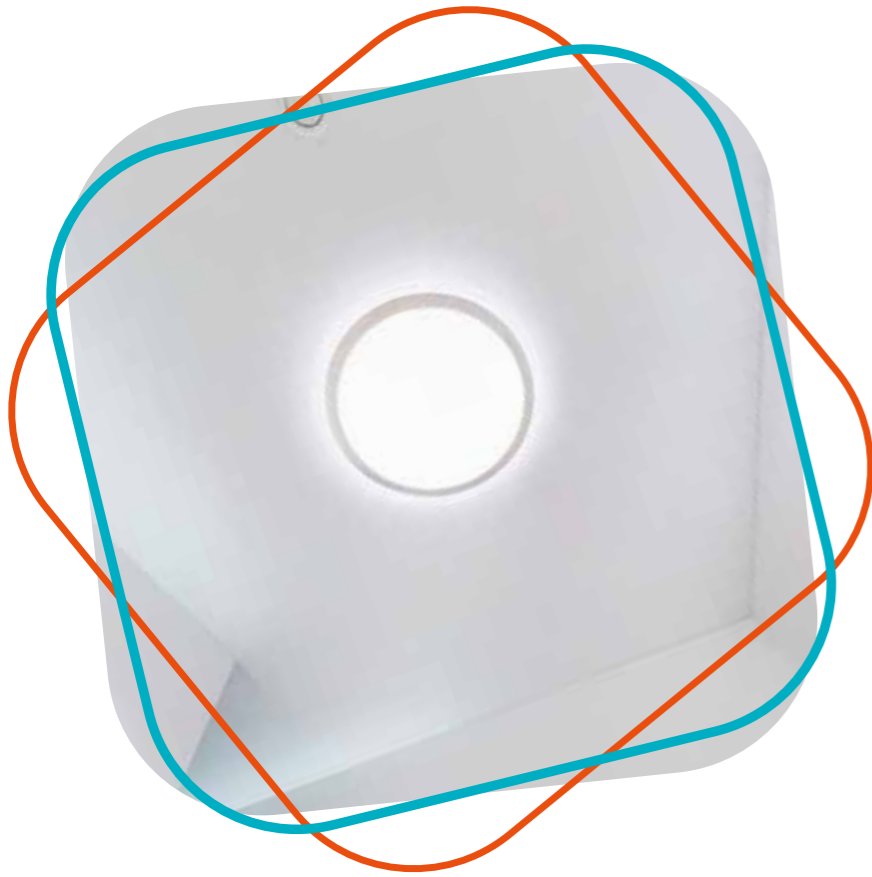

Mikrovalni detektor pokreta
Šifra 407-201, 407-202, 407-203
 Microwave motion detector
 Art.No. 407-201, 407-202, 407-203



Vodootporna kutija za ožičenje se nalazi s vanjske strane kućišta pa nema potrebe za otvaranjem svjetiljke prilikom montaže

The waterproof wiring box is located on the outer side of housing so there is no need for disassembling the lamp housing when mounting

Stezaljke za prihvat kabela bez vijaka omogućavaju jednostavnu i brzu montažu

Screwless cable clamps allow easy and quick mounting

Šifra / Art. No.	Snaga / Power	Svjetlosni tok svjetiljke / Luminaires luminous flux	Svjetlosni tok izvora svjetlosti / Light source luminous flux	Detektor pokreta / Motion detector	Temperatura svjetla / Color temperature	Indeks uzvratne boje / CRI	Životni vijek / Lifespan	Promjer svjetiljke / Lamp diameter	Stupanj zaštite / IP grade	Nazivni napon / Input voltage	Kom./kutija / Pcs/ctn	EAN
407-101	15 W	1500 lm	2000 lm	-	4000 K	RA >80	30.000 h	220 mm	IP54	220-240 V~ 50/60 Hz	10	3858890444636
407-102	18 W	1850 lm	2550 lm	-	4000 K	RA >80	30.000 h	280 mm	IP54	220-240 V~ 50/60 Hz	10	3858890444643
407-103	24 W	2500 lm	3200 lm	-	4000 K	RA >80	30.000 h	330 mm	IP54	220-240 V~ 50/60 Hz	10	3858890444650
407-201	15 W	1500 lm	2000 lm	4 - 8 m	4000 K	RA >80	30.000 h	220 mm	IP54	220-240 V~ 50/60 Hz	10	3858890448979
407-202	18 W	1850 lm	2550 lm	4 - 8 m	4000 K	RA >80	30.000 h	280 mm	IP54	220-240 V~ 50/60 Hz	10	3858890448986
407-203	24 W	2500 lm	3200 lm	4 - 8 m	4000 K	RA >80	30.000 h	330 mm	IP54	220-240 V~ 50/60 Hz	10	3858890448993

3U1 LED PLAFONJERE
 3 IN 1 LED CEILING LAMPS



Sa sklopkom za odabir temperature svjetla

With CCT switch for color temperature adjustment

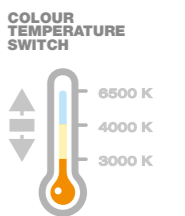

Šifra / Art. No.	Snaga / Power	Svjetlosni tok svjetiljke / Luminaires luminous flux	Svjetlosni tok izvora svjetlosti / Light source luminous flux	Temperatura svjetla / Color temperature	Indeks uzvratne boje / CRI	Životni vijek / Lifespan	Promjer svjetiljke / Lamp diameter	Stupanj zaštite / IP grade	Nazivni napon / Input voltage	Kom./kutija / Pcs/ctn	EAN
407-105	18 W	1800 lm	1880 lm	3000/4000/6500 K	RA >80	25.000 h	220 mm	IP54	165-265 V~ 50/60 Hz	20	3856024402651
407-106	24 W	2400 lm	2565 lm	3000/4000/6500 K	RA >80	25.000 h	280 mm	IP54	165-265 V~ 50/60 Hz	10	3856024402668
407-107	30 W	3000 lm	3255 lm	3000/4000/6500 K	RA >80	25.000 h	330 mm	IP54	165-265 V~ 50/60 Hz	10	3856024402675

LED paneli

Elegantan način osvjetljavanja Vaših poslovnih i stambenih prostora moguć je s novom generacijom učinkovitih LED panela. Zamjenom klasičnih rasvjetnih tijela ne dobiva se samo ljepši izgled već i značajna ušteda energije, čak do 85%.

LED Panels

With a new generation of highly efficient LED panels, it is possible to illuminate your business and residential premises in a more elegant way. By replacing the traditional lighting fixtures you will get not only a more attractive design but also significant energy savings of up to 85%.



Šifra / Art. No.	Snaga / Power	Svjetlosni tok svjetiljke / Luminaire luminous flux	Svjetlosni tok izvora svjetlosti / Light source luminous flux	Temperatura svjetla / Color temperature	Indeks uzvrata boje / CRI	Životni vijek / Lifespan	Promjer svjetiljke / Lamp diameter	Promjer otvora za montažu / Cutout diameter	Nazivni napon / Input voltage	Kom./kutija / Pcs./cbin	EAN
337-351	3 W	240 lm	260 lm	3000 K	RA >80	25.000 h	90 mm	75 mm	220-240 V~ 50/60 Hz	10	3856024402088
337-352	3 W	240 lm	260 lm	4000 K	RA >80	25.000 h	90 mm	75 mm	220-240 V~ 50/60 Hz	10	3856024402095
337-362	6 W	480 lm	520 lm	4000 K	RA >80	25.000 h	120 mm	108 mm	220-240 V~ 50/60 Hz	10	3856024402101
337-372	12 W	960 lm	1200 lm	4000 K	RA >80	25.000 h	170 mm	158 mm	220-240 V~ 50/60 Hz	10	3856024402118
337-382	18 W	1440 lm	1850 lm	4000 K	RA >80	25.000 h	225 mm	206 mm	220-240 V~ 50/60 Hz	10	3856024402125





 **Integrirani driver**
Integrated driver

 **Brza montaža LED panela na nosač - "klik" sistem, bez upotrebe odvijača**
Quick and easy mounting of LED panel - "click" system, without the use of a screwdriver

Šifra / Art. No.	Snaga / Power	Svjetlosni tok svjetiljke / Luminaires luminous flux	Svjetlosni tok izvora svjetlosti / Light source luminous flux	Temperatura svjetla / Color temperature	Indeks uzvratne boje / CRI	Životni vijek / Lifespan	Promjer svjetiljke / Lamp diameter	Nazivni napon / Input voltage	Kom./kutija / Pcs/ctn	EAN
337-366	6 W	480 lm	520 lm	4000 K	RA >80	25.000 h	120 mm	220-240 V~ 50/60 Hz	10	3856024402132
337-376	12 W	960 lm	1200 lm	4000 K	RA >80	25.000 h	170 mm	220-240 V~ 50/60 Hz	10	3856024402149

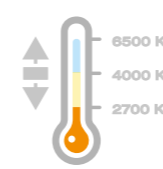
COLOUR TEMPERATURE SWITCH



 **Integrirani driver**
Integrated driver

Šifra / Art. No.	Snaga / Power	Svjetlosni tok svjetiljke / Luminaires luminous flux	Svjetlosni tok izvora svjetlosti / Light source luminous flux	Temperatura svjetla / Color temperature	Indeks uzvratne boje / CRI	Životni vijek / Lifespan	Promjer svjetiljke / Lamp diameter	Promjer otvora za montažu / Cutout diameter	Nazivni napon / Input voltage	Kom./kutija / Pcs/ctn	EAN
337-304	6 W	400 lm	525 lm	2700/4000/6500 K	RA >80	25.000 h	115 mm	105 mm	220-240 V~ 50/60 Hz	50	3856024402323
337-314	12 W	900 lm	1190 lm	2700/4000/6500 K	RA >80	25.000 h	170 mm	155 mm	220-240 V~ 50/60 Hz	40	3856024402330
337-324	18 W	1500 lm	1880 lm	2700/4000/6500 K	RA >80	25.000 h	220 mm	205 mm	220-240 V~ 50/60 Hz	20	3856024402347
337-334	24 W	1950 lm	2565 lm	2700/4000/6500 K	RA >80	25.000 h	240 mm	225 mm	220-240 V~ 50/60 Hz	20	3856024402422

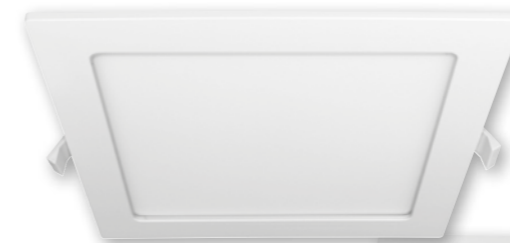

COLOUR TEMPERATURE SWITCH

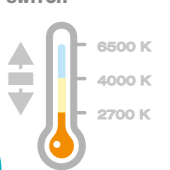

 **Integrirani driver**
Integrated driver

Šifra / Art. No.	Snaga / Power	Svjetlosni tok svjetiljke / Luminaires luminous flux	Svjetlosni tok izvora svjetlosti / Light source luminous flux	Temperatura svjetla / Color temperature	Indeks uzvratne boje / CRI	Životni vijek / Lifespan	Dimenzije svjetiljke / Lamp dimenzije	Dimenzije otvora za montažu / Cutout dimensions	Nazivni napon / Input voltage	Kom./kutija / Pcs/ctn	EAN
337-404	6 W	400 lm	525 lm	2700/4000/6500 K	RA >80	25.000 h	120 x 120 mm	105 x 105 mm	220-240 V~ 50/60 Hz	50	3856024402439
337-414	12 W	900 lm	1190 lm	2700/4000/6500 K	RA >80	25.000 h	170 x 170 mm	155 x 155 mm	220-240 V~ 50/60 Hz	40	3856024402446
337-424	18 W	1500 lm	1880 lm	2700/4000/6500 K	RA >80	25.000 h	220 x 220 mm	205 x 205 mm	220-240 V~ 50/60 Hz	20	3856024402354
337-434	24 W	1950 lm	2565 lm	2700/4000/6500 K	RA >80	25.000 h	220 x 220 mm	205 x 205 mm	220-240 V~ 50/60 Hz	20	3856024402453

COLOUR TEMPERATURE SWITCH

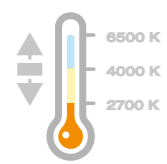

Integrirani driver
Integrated driver

Brza montaža LED panela na nosač - "klik" sistem, bez upotrebe odvijača
Quick and easy mounting of LED panel - "click" system, without the use of a screwdriver

Šifra / Art. No.	Snaga / Power	Svjetošni tok svjetiljke / Luminaires luminous flux	Svjetošni tok izvora svjetlosti / Light source luminous flux	Temperatura svjetla / Color temperature	Faktor snage / Power factor	Indeks uzvrata boje / CRI	Životni vijek / Lifespan	Promjer svjetiljke / Lamp diameter	Nazivni napon / Input voltage	Kom./kutija / Pcs/ctn	EAN
337-308	6 W	400 lm	525 lm	2700/4000/6500 K	>0.9	RA >80	25.000 h	122 mm	220-240V ~ 50/60Hz	50	3856024402361
337-318	12 W	900 lm	1190 lm	2700/4000/6500 K	>0.9	RA >80	25.000 h	177 mm	220-240V ~ 50/60Hz	40	3856024402378
337-328	18 W	1500 lm	1880 lm	2700/4000/6500 K	>0.9	RA >80	25.000 h	226 mm	220-240V ~ 50/60Hz	20	3856024402385
337-338	24 W	1950 lm	2565 lm	2700/4000/6500 K	>0.9	RA >80	25.000 h	245 mm	220-240V ~ 50/60Hz	20	3856024402392

COLOUR TEMPERATURE SWITCH

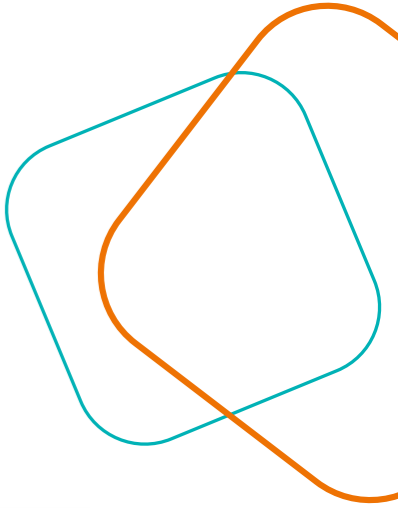
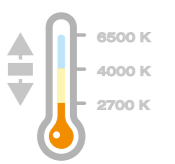

Integrirani driver
Integrated driver

Brza montaža LED panela na nosač - "klik" sistem, bez upotrebe odvijača
Quick and easy mounting of LED panel - "click" system, without the use of a screwdriver

Šifra / Art. No.	Snaga / Power	Svjetošni tok svjetiljke / Luminaires luminous flux	Svjetošni tok izvora svjetlosti / Light source luminous flux	Temperatura svjetla / Color temperature	Faktor snage / Power factor	Indeks uzvrata boje / CRI	Životni vijek / Lifespan	Dimenzije svjetiljke / Lamp dimensions	Nazivni napon / Input voltage	Kom./kutija / Pcs/ctn	EAN
337-408	6 W	400 lm	525 lm	2700/4000/6500 K	>0.9	RA >80	25.000 h	122x122 mm	220-240V ~ 50/60Hz	50	3856024402460
337-418	12 W	900 lm	1190 lm	2700/4000/6500 K	>0.9	RA >80	25.000 h	172x172 mm	220-240V ~ 50/60Hz	40	3856024402477
337-428	18 W	1500 lm	1880 lm	2700/4000/6500 K	>0.9	RA >80	25.000 h	227x227 mm	220-240V ~ 50/60Hz	20	3856024402408
337-438	24 W	1950 lm	2565 lm	2700/4000/6500 K	>0.9	RA >80	25.000 h	227x227 mm	220-240V ~ 50/60Hz	20	3856024402415



Nadgradna i ugradna montaža
Surface and recessed installation



Šifra / Art. No.	Snaga / Power	Svjjetlosni tok / Luminous flux	Svjjetlosni tok izvora / Light source luminous flux	Temperatura svjetla / Color temperature	Indeks uzvratne boje / CRI	Životni vijek / Lifespan	Dimenzije svjetiljke / Lamp dimensions	Nazivni napon / Input voltage	Kom./kutija / Pcs/ctn	EAN
337-602	45 W	4500 lm	5400 lm	4000 K	RA >80	30.000 h	595 x 595 x 35 mm	220-240 V~ 50 Hz	5	3856024404631

Šifra / Art. No.	Snaga / Power	Svjjetlosni tok / Luminous flux	Svjjetlosni tok izvora / Light source luminous flux	Temperatura svjetla / Color temperature	Indeks uzvratne boje / CRI	Životni vijek / Lifespan	Dimenzije svjetiljke / Lamp dimensions	Nazivni napon / Input voltage	Kom./kutija / Pcs/ctn	EAN
337-506	45 W	4500 lm	5400 lm	4000 K	RA >80	30.000 h	595 x 595 x 10 mm	220-240 V~ 50/60 Hz	5	38586024406239
337-507	45 W	4500 lm	5400 lm	6500 K	RA >80	30.000 h	595 x 595 x 10 mm	220-240 V~ 50/60 Hz	5	38586024406246



Šifra / Art. No.	Snaga / Power	Svjjetlosni tok / Luminous flux	Svjjetlosni tok izvora / Light source luminous flux	Temperatura svjetla / Color temperature	Indeks uzvratne boje / CRI	Životni vijek / Lifespan	Dimenzije svjetiljke / Lamp dimensions	Nazivni napon / Input voltage	Kom./kutija / Pcs/ctn	EAN
337-505	40 W	3200 lm	4700 lm	4000 K	RA >80	30.000 h	595 x 595 x 10 mm	180-265 V~ 50/60 Hz	5	3858890447583
337-503	45 W	4500 lm	5400 lm	4000 K	RA >80	30.000 h	595 x 595 x 10 mm	220-240 V~ 50/60 Hz	5	3858890449358
337-504	45 W	4500 lm	5400 lm	6500 K	RA >80	30.000 h	595 x 595 x 10 mm	220-240 V~ 50/60 Hz	5	3858890449365
337-515	40 W	3200 lm	4700 lm	4000 K	RA >80	30.000 h	1195 x 295 x 10 mm	220-240 V~ 50/60 Hz	5	3858890449372



Slika / Photo	Šifra / Art. No.	Opis / Description	Dimenzije svjetiljke / Lamp dimensions	Kom./kutija / Pcs/ctn	EAN
1	337-901	set za nadgradnu montažu LED panela 595x595 mm / surface mount kit for LED panel 595x595 mm	600 x 600 x 50 mm	20	3858890443417
1	337-903	set za nadgradnu montažu LED panela 1195x295 mm / surface mount kit for LED panel 1195x295 mm	1200 x 300 x 50 mm	20	3858890444094
2	337-902	nosači s oprugom za montažu LED panela (pakiranje 4 komada) / spring clips for LED panel (4 pcs)	-	1	3858890443905

LED ugradbene svjetiljke

Zahvaljujući jednostavnom i elegantnom dizajnu, LED ugradbene svjetiljke će se savršeno uklopiti u svaki interijer. Usmjerenim svjetlom idealno ćete naglasiti detalje u Vašem domu ili poslovnom prostoru.

LED Downlights

Thanks to their simple and elegant design, LED downlights will fit perfectly into any interior. With a focused beam of light, you will be able to accentuate the details in your home or office.



Pakiranje sadrži set od 3 svjetiljke
3-pack set of downlights

Šifra / Art. No.	Snaga / Power	Svjjetlosni tok svjetiljke / Luminaires luminous flux	Temperatura svjetla / Color temperature	Indeks uzvrata boje / CRI	Kut snopa svjetlosti / Beam angle	Životni vijek / Lifespan	Promjer svjetiljke / Lamp diameter	Promjer otvora za montažu / Cutout diameter	Nazivni napon / Input voltage	Kom./pak / Pcs./pkg	Kom./kutija / Pcs./ctn	EAN
336-123	3 W	270 lm	3000 K	RA >80	120°	25.000 h	90 mm	70-80 mm	220-240 V~ 50/60 Hz	3	20	3856024406642
336-124	3 W	270 lm	4000 K	RA >80	120°	25.000 h	90 mm	70-80 mm	220-240 V~ 50/60 Hz	3	20	3856024406659



Pakiranje sadrži set od 3 svjetiljke
3-pack set of downlights

Šifra / Art. No.	Snaga / Power	Svjjetlosni tok svjetiljke / Luminaires luminous flux	Temperatura svjetla / Color temperature	Indeks uzvrata boje / CRI	Kut snopa svjetlosti / Beam angle	Životni vijek / Lifespan	Promjer svjetiljke / Lamp diameter	Promjer otvora za montažu / Cutout diameter	Nazivni napon / Input voltage	Kom./pak / Pcs./pkg	Kom./kutija / Pcs./ctn	EAN
336-126	5 W	370 lm	3000 K	RA >80	38°	25.000 h	90 mm	70-80 mm	220-240 V~ 50/60 Hz	3	20	3856024406666
336-127	5 W	370 lm	4000 K	RA >80	38°	25.000 h	90 mm	70-80 mm	220-240 V~ 50/60 Hz	3	20	3856024406673



LED cijevi

Commel LED cijevi namijenjene su za ugradnju u sve vrste raster i vodotijesnih svjetiljki. Kućište od nano polikarbonata smanjuje mogućnost mehaničkog oštećenja prilikom montaže ili transporta uz bolje raspršivanje svjetlosti.

LED Tubes

Commel LED tubes are designed for installation in all types of grille and waterproof light fixtures. The nano PC housing reduces the possibility of mechanical damage when mounting or transporting and provides higher dispersion of light.









 Napajanje s jedne strane
Single end input

 Montaža u svjetiljke bez prigušnice i startera
Mounting in lamps without ballast or starter



 Nano PC - LED cijevi s difuzorom od nano polikarbonata imaju mnogo prednosti u odnosu na LED cijevi sa staklenim ili plastičnim difuzorom. Nano polikarbonat omogućuje odličnu provodljivost i bolje raspršivanje svjetlosti te otpornost na mehanička oštećenja

Nano PC - LED tubes with nano polycarbonate diffuser have many advantages over LED tubes with glass or plastic diffuser. Nano polycarbonate provides excellent transmittance and higher dispersion of light, and also high resistance to mechanical damage

Šifra / Art. No.	Snaga / Power	Tip / Type	Svjetlosni tok / Luminous flux	Temperatura svjetla / Color temperature	Indeks uzvrata boje / CRI	Životni vijek / Lifespan	Nazivni napon / Input voltage	Kom./kutija / Pcs/cin	EAN	
305-607	9 W	T8 60 cm	990 lm	4000 K	RA >80	30.000 h	220-240 V~ 50 Hz	25	3856024404570	
305-617	9 W	T8 60 cm	990 lm	6500 K	RA >80	30.000 h	220-240 V~ 50 Hz	25	3856024404587	
305-608	18 W	T8 120 cm	1980 lm	4000 K	RA >80	30.000 h	220-240 V~ 50 Hz	25	3856024404594	
305-618	18 W	T8 120 cm	1980 lm	6500 K	RA >80	30.000 h	220-240 V~ 50 Hz	25	3856024404600	
305-609	24 W	T8 150 cm	2640 lm	4000 K	RA >80	30.000 h	220-240 V~ 50 Hz	25	3856024404617	
305-619	24 W	T8 150 cm	2640 lm	6500 K	RA >80	30.000 h	220-240 V~ 50 Hz	25	3856024404624	

LED vodotijesne svjetiljke

Kućište od ABS plastike i difuzor od polikarbonata uz ugrađene visokokvalitetne Commel LED cijevi i integrirane LED sklopove omogućuju LED vodotijesnim svjetilkama vrhunske karakteristike uz minimalne troškove električne energije. Zbog vrlo visokog stupnja IP zaštite pogodne su za ugradnju u vrlo vlažne prostore.

LED Waterproof Light Fixtures

ABS housing, polycarbonate diffuser, built-in high quality integrated LED or Commel LED tubes along with low power consumption, provide the highest quality performance of Commel LED waterproof light fixtures. Due to a very high IP degree of protection they are suitable for installation in very damp spaces.

Commel®



IP65 brzi konektor za spajanja kabela
IP65 quick cable connector

Šifra / Art. No.	Snaga / Power	Svjetlosni tok svjetiljke / Luminaires luminous flux	Svjetlosni tok izvora svjetlosti / Light source luminous flux	Temperatura svjetla / Color temperature	Indeks uzvratne boje / CRI	Životni vijek / Lifespan	Materijal kućišta / Housing material	Dimenzije / Dimensions	Stupanj zaštite / IP grade	Nazivni napon / Input voltage	Kom./kutija / Pcs/ctn	EAN
344-683	18 W	2350 lm	2520 lm	4000 K	RA >80	50.000 h	PC	600x69x49 mm	IP65	220-240 V~ 50/60 Hz	12	3856024406345
344-681	36 W	4700 lm	5040 lm	4000 K	RA >80	50.000 h	PC	1280x69x49 mm	IP65	220-240 V~ 50/60 Hz	12	3856024406338
344-686	50 W	6500 lm	7000 lm	4000 K	RA >80	50.000 h	PC	1500x69x49 mm	IP65	220-240 V~ 50/60 Hz	12	3856024406352

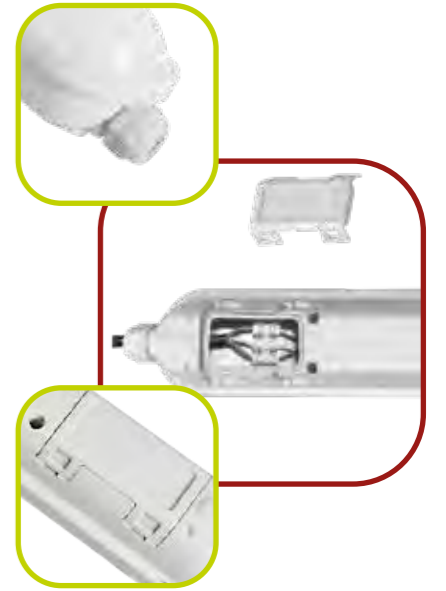
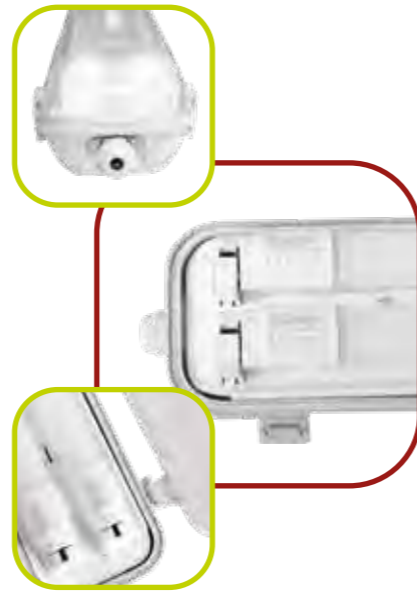
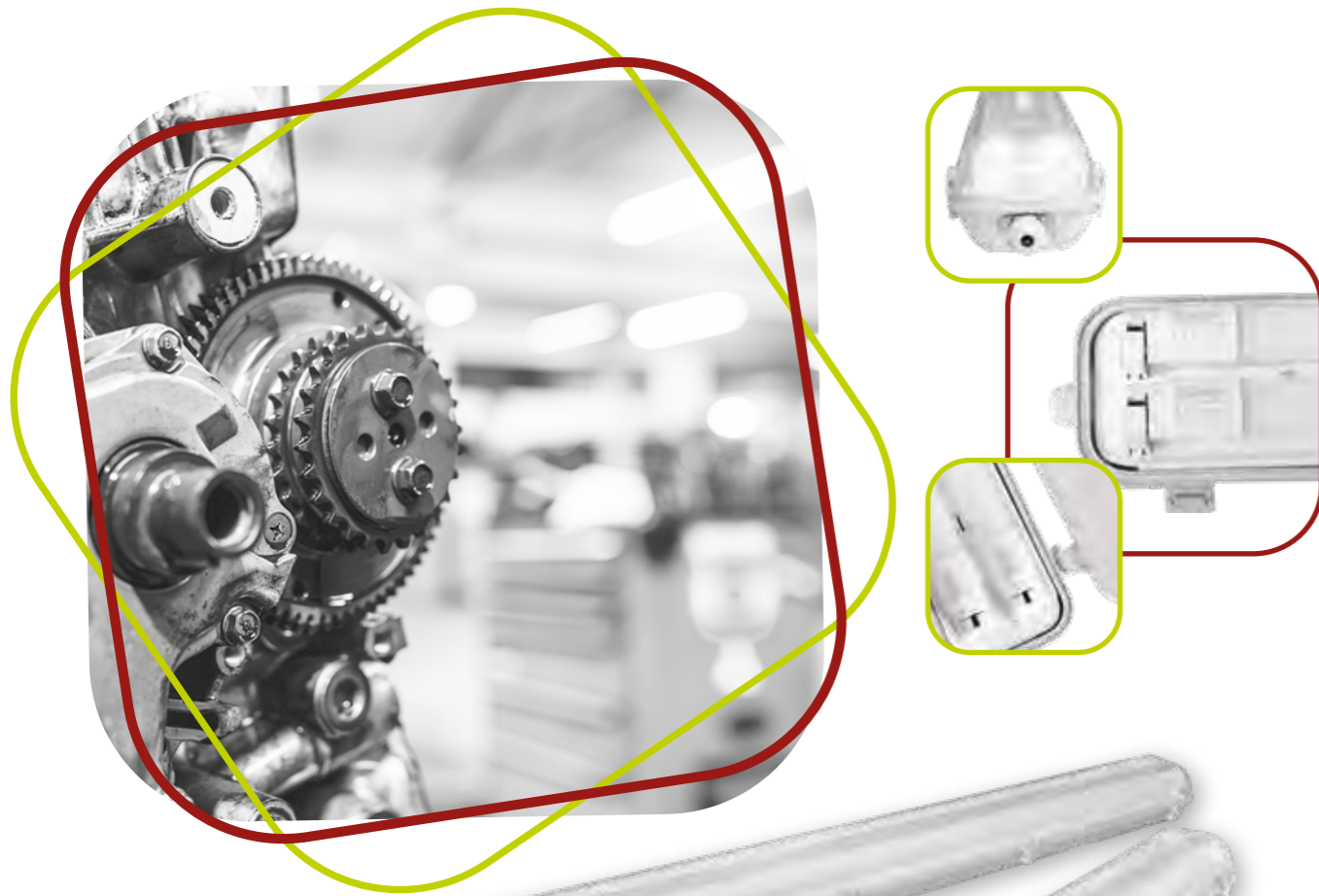

5 godina jamstva
5 year warranty

Šifra / Art. No.	Tip / Type	Svjetlosni tok / Luminous flux	Temperatura svjetla / Color temperature	Indeks uzvrata boje / CRI	Životni vijek / Lifespan	Materijal kućišta / Housing material	Dimenzije / Dimensions	Stupanj zaštite / IP grade	Nazivni napon / Input voltage	Kom./kutija / Pcs/ctn	EAN
344-607	2 x 10 W	2 x 1000 lm	4000 K	RA >80	25.000 h	ABS+PC	660x80x96 mm	IP65	220-240 V~ 50/60 Hz	8	3856024402071
344-617	2 x 10 W	2 x 1000 lm	6500 K	RA >80	25.000 h	ABS+PC	660x80x96 mm	IP65	220-240 V~ 50/60 Hz	8	3856024402040
344-608	2 x 18 W	2 x 1900 lm	4000 K	RA >80	25.000 h	ABS+PC	1260x80x96 mm	IP65	220-240 V~ 50/60 Hz	8	3856024402026
344-618	2 x 18 W	2 x 1900 lm	6500 K	RA >80	25.000 h	ABS+PC	1260x80x96 mm	IP65	220-240 V~ 50/60 Hz	8	3856024402057
344-609	2 x 24 W	2 x 2550 lm	4000 K	RA >80	25.000 h	ABS+PC	1560x80x96 mm	IP65	220-240 V~ 50/60 Hz	8	3856024402033
344-619	2 x 24 W	2 x 2550 lm	6500 K	RA >80	25.000 h	ABS+PC	1560x80x96 mm	IP65	220-240 V~ 50/60 Hz	8	3856024402064

Šifra / Art. No.	Snaga / Power	Svjetlosni tok svjetiljke / Luminare luminous flux	Svjetlosni tok izvora svjetlosti / Light source luminous flux	Temperatura svjetla / Color temperature	Indeks uzvrata boje / CRI	Životni vijek / Lifespan	Materijal kućišta / Housing material	Dimenzije / Dimensions	Stupanj zaštite / IP grade	Nazivni napon / Input voltage	Kom./kutija / Pcs/ctn	EAN
344-663	21 W	2520 lm	3000 lm	4000 K	RA >80	30.000 h	PC	590x72x61 mm	IP65	220-240 V~ 50/60 Hz	15	3856024402606
344-661	40 W	4800 lm	5600 lm	4000 K	RA >80	30.000 h	PC	1180x72x61 mm	IP65	220-240 V~ 50/60 Hz	12	3856024402590
344-666	55 W	6600 lm	7400 lm	4000 K	RA >80	30.000 h	PC	1480x72x61 mm	IP65	220-240 V~ 50/60 Hz	9	3856024402613

Panik svjetiljke

Commel LED panik svjetiljke vrhunske su kvalitete i trajnosti. Autonomija rada u panik modu od 3 sata omogućuje siguran izlaz iz zatvorenih prostora u slučaju nestanka električne energije. Vrlo visoki stupanj IP zaštite omogućuje montažu u vlažne prostore.

Emergency Light Fixtures

Commel LED emergency light fixtures are of very high quality and are very durable. Emergency operation time of 3 hours allows safe exit from enclosed areas in the event of power failure. A very high degree of IP protection enables installation in damp spaces.



LED PANIK SVJETILJKE LED EMERGENCY LIGHT FIXTURES



Li-FePO4 18650 3.2 V 1000 mAh
Li-FePO4 18650 3.2 V 1000 mAh

Šifra / Art. No.	Snaga / Power	Svjetlosni tok / Luminous flux	Autonomija rada / Working autonomy	Temperatura svjetla / Color temperature	Dimenzije / Dimensions	Stupanj zaštite / IP grade	Nazivni napon / Input voltage	Kom./kutija / Pcs/ctn	EAN
346-204	2.5 W	170 lm	3 h	6500 K	352 x 110 x 64 mm	IP65	220-240 V~ 50/60 Hz	12	3856024406710



Li-FePO4 18650 3.2 V 1000 mAh
Li-FePO4 18650 3.2 V 1000 mAh

Šifra / Art. No.	Snaga / Power	Svjetlosni tok / Luminous flux	Autonomija rada / Working autonomy	Temperatura svjetla / Color temperature	Dimenzije / Dimensions	Stupanj zaštite / IP grade	Nazivni napon / Input voltage	Kom./kutija / Pcs/ctn	EAN
346-202	3.3 W	150 lm	3 h	6000 K	254 x 93 x 56 mm	IP65	220-240 V~ 50 Hz	20	3856024401869

Šifra / Art. No.	Naziv / Name	Tip baterije / Battery type	Kom./kutija / Pcs/ctn	EAN
346-901	Baterija za panik svjetiljke 346-201 / Battery for emergency light 346-201	NiCd 3.6V 1500mAh	45	3858890448498
346-902	Baterija za panik svjetiljke 346-202 / Battery for emergency light 346-202	NiCd 3.6V 800mAh	45	3856024406253

Zidna instalacija
Wall installation

Stropna instalacija
Ceiling installation

Šifra / Art. No.	Snaga / Power	Autonomija rada / Working autonomy	Baterija / Battery	Dimenzije / Dimensions	Stupanj zaštite / IP grade	Nazivni napon / Input voltage	Kom./kutija / Pcs/ctn	EAN
346-203	2.2 W	3 h	Ni-Cd 3.6 V 800 mAh	345 x 215 x 40 mm	IP20	220-240 V~ 50 Hz	6	3856024403856

Solarni LED reflektori

Commel solarne reflektore odlikuje visoka razina osvjetljenja i duga autonomija rada. Ne zahtijevaju dodatni izvor napajanja pa pokrivaju neograničena područja primjene. Zahvaljujući modernom dizajnu savršeno će se uklopiti u svaki vanjski ambijent.

Solar LED Floodlights

Commel solar floodlights provide a high level of illumination and long working autonomy. They do not require an additional power source, so they cover unlimited areas of application. Thanks to the modern design, they will fit perfectly into any outdoor environment.

Commel®



2 godine jamstva
2 year warranty



2 načina montaže
2 mounting ways



2 načina rada
2 working modes

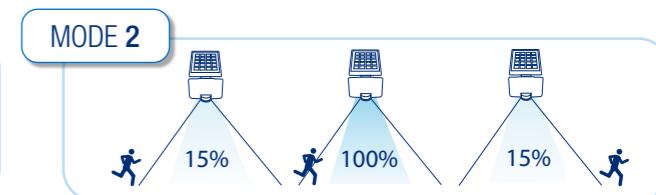
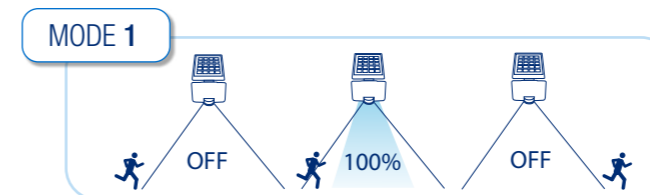

Šifra / Art. No.	Snaga / Power	Svjetlosni tok / Luminous flux	Baterija / Battery	Temperatura svjetla / Color temperature	Dimenzije / Dimensions	Stupanj zaštite / IP grade	Kom./kutija / Pcs/ctn	EAN
309-101	8 W	800 lm	18650 3.7V 2000mAh	4000 K	290 x 178 x 140 mm	IP54	12	3856024403580
309-102	11 W	1500 lm	18650 3.7V 4000mAh	4000 K	290 x 178 x 140 mm	IP54	12	3856024403597

2 godine jamstva
2 year warranty

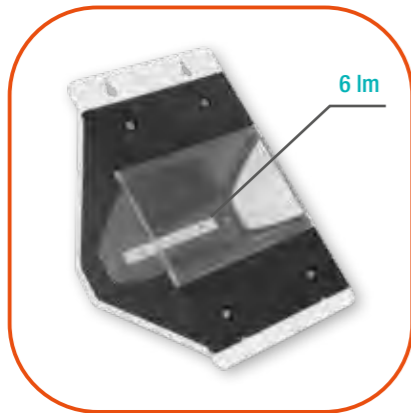
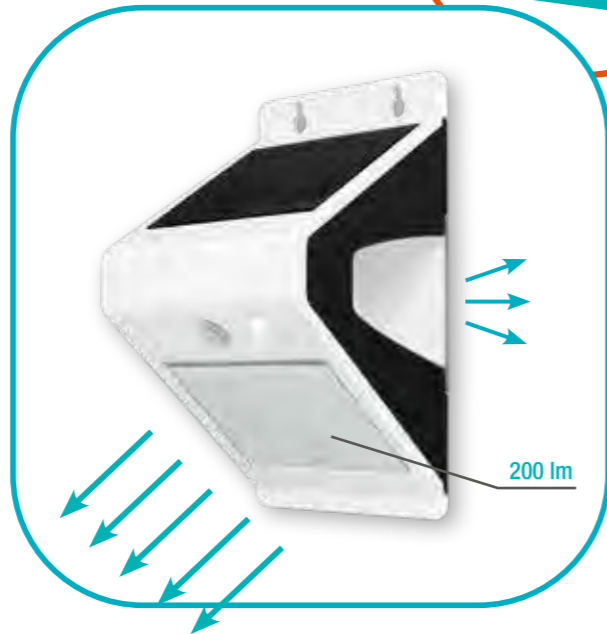

2 godine jamstva
2 year warranty

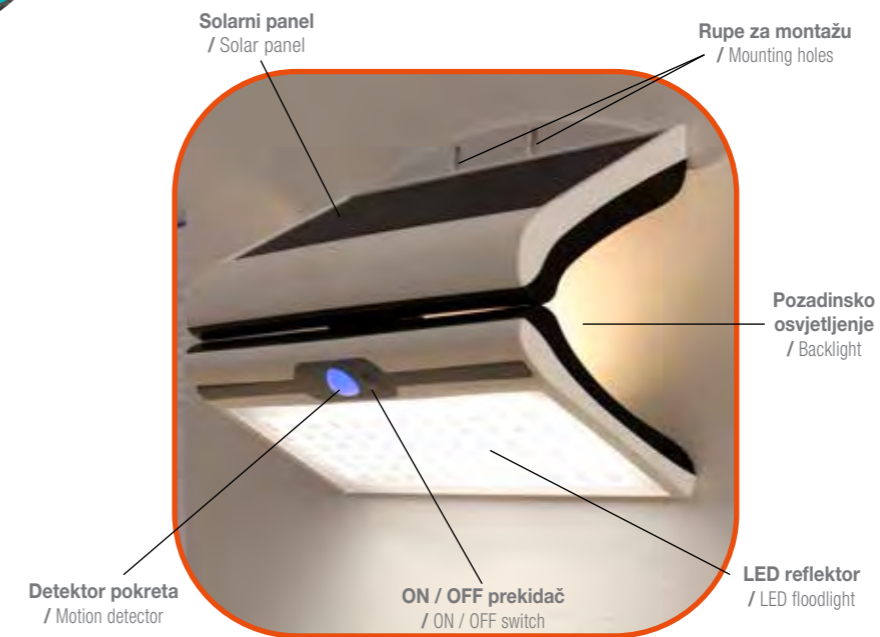

2 načina rada
2 working modes

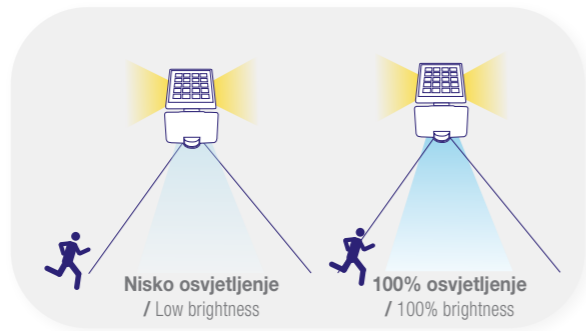

2 načina rada
2 working modes

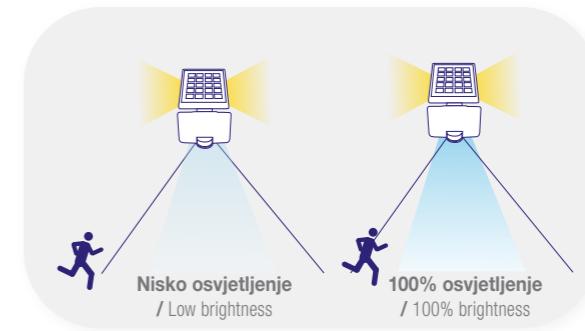

Šifra / Art. No.	Snaga / Power	Svjetlosni tok / Luminous flux	Baterija / Battery	Temperatura svjetla prednje i pozadinsko / Color temperature front and back light	Dimenzije / Dimensions	Stupanj zaštite / IP grade	Kom./kutija / Pcs/cin	EAN
309-103	3 W	200 lm	18650 3.7V 1200mAh	4000 K + 3000 K	155 x 95 x 80 mm	IP44	24	3856024406024

Šifra / Art. No.	Snaga / Power	Svjetlosni tok / Luminous flux	Baterija / Battery	Temperatura svjetla prednje i pozadinsko / Color temperature front and back light	Dimenzije / Dimensions	Stupanj zaštite / IP grade	Kom./kutija / Pcs/cin	EAN
309-104	4,5 W	430 lm	18650 3.7V 3000mAh	4000 K + 3000 K	190 x 230 x 101 mm	IP44	20	3856024406031

LED reflektori

Svi možete pronaći nešto za svoje potrebe u asortimanu Commel LED reflektora. Bilo da tražite dekorativni, radni ili profesionalni, a uz to i pristupačan LED reflektor, sve je tu. Izbor je na Vama!

LED Floodlights

Commel offers a wide range of LED floodlights. Whether you are looking for a decorative floodlight, work, professional, but also an affordable one, it is all there. The choice is yours!



Visoka kvaliteta, elegantan dizajn i pristupačna cijena glavne su odlike ove linije.

High quality, elegant design and affordable price are the main features of this line.



DETEKTOR POKRETA - podešavanje vremena, osjetljivosti i razine ambijentalnog osvjetljenja

MOTION DETECTOR - Adjustment of time, sensitivity and ambient light level

Sifra / Art. No.	Boja / Color	Snaga / Power	Detektor pokreta / Motion detector	Svjetlosni tok / Luminous flux	Temperatura svjetla / Color temperature	Kut snopa svjetlosti / Beam angle	Životni vijek / Lifespan	Stupanj zaštite / IP grade	Nazivni napon / Input voltage	Kom. /kutija / Pcs/cdn	EAN	
306-119	bijela / white	10 W	-	800 lm	4000 K	120°	30.000 h	IP65	220-240 V~ 50/60 Hz	60	3856024402729	F A B
306-219	crna / black	10 W	-	800 lm	4000 K	120°	30.000 h	IP65	220-240 V~ 50/60 Hz	60	3856024402736	F A B
306-129	bijela / white	20 W	-	1600 lm	4000 K	120°	30.000 h	IP65	220-240 V~ 50/60 Hz	40	3856024402743	F A B
306-229	crna / black	20 W	-	1600 lm	4000 K	120°	30.000 h	IP65	220-240 V~ 50/60 Hz	40	3856024402750	F A B
306-139	bijela / white	30 W	-	2550 lm	4000 K	120°	30.000 h	IP65	220-240 V~ 50/60 Hz	30	3856024402767	F A B
306-239	crna / black	30 W	-	2550 lm	4000 K	120°	30.000 h	IP65	220-240 V~ 50/60 Hz	30	3856024402774	F A B
306-159	bijela / white	50 W	-	4250 lm	4000 K	120°	30.000 h	IP65	220-240 V~ 50/60 Hz	20	3856024402781	F A B
306-259	crna / black	50 W	-	4250 lm	4000 K	120°	30.000 h	IP65	220-240 V~ 50/60 Hz	20	3856024402798	F A B
306-199	bijela / white	100 W	-	8500 lm	4000 K	120°	30.000 h	IP65	220-240 V~ 50/60 Hz	10	3856024402804	F A B
306-299	crna / black	100 W	-	8500 lm	4000 K	120°	30.000 h	IP65	220-240 V~ 50/60 Hz	10	3856024402811	F A B
307-119	bijela / white	10 W	120°	800 lm	4000 K	120°	30.000 h	IP44	220-240 V~ 50/60 Hz	60	3856024402828	F A B
307-219	crna / black	10 W	120°	800 lm	4000 K	120°	30.000 h	IP44	220-240 V~ 50/60 Hz	60	3856024402835	F A B
307-129	bijela / white	20 W	120°	1600 lm	4000 K	120°	30.000 h	IP44	220-240 V~ 50/60 Hz	40	3856024402842	F A B
307-229	crna / black	20 W	120°	1600 lm	4000 K	120°	30.000 h	IP44	220-240 V~ 50/60 Hz	40	3856024402859	F A B
307-139	bijela / white	30 W	120°	2550 lm	4000 K	120°	30.000 h	IP44	220-240 V~ 50/60 Hz	20	3856024402866	F A B
307-239	crna / black	30 W	120°	2550 lm	4000 K	120°	30.000 h	IP44	220-240 V~ 50/60 Hz	20	3856024402873	F A B
307-159	bijela / white	50 W	120°	4250 lm	4000 K	120°	30.000 h	IP44	220-240 V~ 50/60 Hz	20	3856024402880	F A B
307-259	crna / black	50 W	120°	4250 lm	4000 K	120°	30.000 h	IP44	220-240 V~ 50/60 Hz	20	3856024402897	F A B



Šifra / Art. No.	Boja / Color	Snaga / Power	Detektor pokreta / Motion detector	Svjetlosni tok / Luminous flux	Temperatura svjetla / Color temperature	Kut snopa svjetlosti / Beam angle	Životni vijek / Lifespan	Stupanj zaštite / IP grade	Nazivni napon / Input voltage	Kom./kutija / Pcs/cdn	EAN
306-201	crna / black	150 W	-	13000 lm	4000 K	120°	30.000 h	IP65	220-240 V~ 50/60 Hz	5	3856024404488
306-202	crna / black	200 W	-	17000 lm	4000 K	120°	30.000 h	IP65	220-240 V~ 50/60 Hz	5	3856024404495



Waterproof konektor
Waterproof connector

2 godine jamstva
2 year warranty

Detektor pokreta s mogućnošću podešavanja načina rada
Motion detector with adjustable settings

Šifra / Art. No.	Snaga / Power	Svjetlosni tok / Luminous flux	Detektor pokreta / Motion detector	Temperatura svjetla / Color temperature	Kut snopa svjetlosti / Beam angle	Životni vijek / Lifespan	Stupanj zaštite / IP grade	Dimenzije / Dimensions	Nazivni napon / Input voltage	Kom./kutija / Pcs/cdn	EAN
306-213	10 W	1 x 1000 lm	-	4000 K	120°	25.000 h	IP65	103 x 60 x 74 mm	220-240 V~ 50 Hz	60	3856024402934
306-223	20 W	1 x 2100 lm	-	4000 K	120°	25.000 h	IP65	122 x 60 x 97 mm	220-240 V~ 50 Hz	50	3856024402941
306-233	30 W	1 x 3200 lm	-	4000 K	120°	25.000 h	IP65	148 x 60 x 112 mm	220-240 V~ 50 Hz	30	3856024402958
306-253	50 W	1 x 5400 lm	-	4000 K	120°	25.000 h	IP65	196 x 62 x 146 mm	220-240 V~ 50 Hz	20	3856024402965
307-223	20 W	1 x 2100 lm	120°	4000 K	120°	25.000 h	IP44	124 x 73 x 180 mm	220-240 V~ 50 Hz	40	3856024402972
307-233	30 W	1 x 3200 lm	120°	4000 K	120°	25.000 h	IP44	148 x 73 x 200 mm	220-240 V~ 50 Hz	20	3856024402989
307-253	50 W	1 x 5400 lm	120°	4000 K	120°	25.000 h	IP44	198 x 73 x 234 mm	220-240 V~ 50 Hz	10	3856024402996

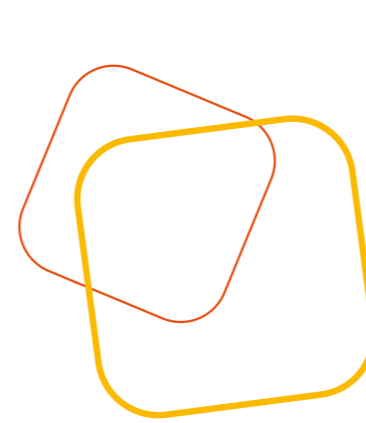

Premium Line



Šifra / Art. No.	Boja / Color	Snaga / Power	Svjetlosni tok / Luminous flux	Dimenzije / Dimensions	Temperatura svjetla / Color temperature	Kut snopa svjetlosti / Beam angle	Životni vijek / Lifespan	Stupanj zaštite / IP grade	Nazivni napon / Input voltage	Kom./kutija / Pcs/cdn	EAN
306-271	crna / black	70 W	9450 lm	255 x 198 x 36 mm	4000 K	120°	50.000 h	IP65	220-240 V~ 50/60 Hz	10	3856024403504
306-272	crna / black	100 W	13500 lm	315 x 233 x 38 mm	4000 K	120°	50.000 h	IP65	220-240 V~ 50/60 Hz	5	3856024403511
306-273	crna / black	150 W	20250 lm	375 x 280 x 38 mm	4000 K	120°	50.000 h	IP65	220-240 V~ 50/60 Hz	5	3856024403528
306-274	crna / black	200 W	27000 lm	410 x 298 x 40 mm	4000 K	120°	50.000 h	IP65	220-240 V~ 50/60 Hz	4	3856024403535

5 godina jamstva
5 year warranty

50 000 h životni vijek
50 000 h lifespan





H05RN-F kabel s IP44 šuko utikačem
H05RN-F cable with IP44 Schuko plug

Šifra / Art. No.	Tip / Type	Svjetlosni tok / Luminous flux	Temperatura svjetla / Color temperature	Kut snopa svjetlosti / Beam angle	Životni vijek / Lifespan	Stupanj zaštite / IP grade	Kabel / Cable	Nazivni napon / Input voltage	Kom./kutija / Pcs/ctn	EAN
308-213	10 W	1 x 1000 lm	6500 K	120°	25.000 h	IP44	H05RN-F 3G1 / 2,5 m	220-240 V~ 50 / 60 Hz	10	3856024403764
308-233	30 W	1 x 3200 lm	6500 K	120°	25.000 h	IP44	H05RN-F 3G1 / 2,5 m	220-240 V~ 50 / 60 Hz	10	3856024403771
308-253	50 W	1 x 5400 lm	6500 K	120°	25.000 h	IP44	H05RN-F 3G1 / 2,5 m	220-240 V~ 50 / 60 Hz	8	3856024403801



H05RN-F kabel s IP44 šuko utikačem
H05RN-F cable with IP44 Schuko plug

Teleskopski stalak s mogućnošću podešavanja visine
Height adjustable tripod telescopic stand

Šifra / Art. No.	Tip / Type	Svjetlosni tok / Luminous flux	Temperatura svjetla / Color temperature	Kut snopa svjetlosti / Beam angle	Životni vijek / Lifespan	Stupanj zaštite / IP grade	Kabel / Cable	Nazivni napon / Input voltage	Kom./kutija / Pcs/ctn	EAN
308-433	1 x 30 W	1 x 3200 lm	6500 K	120°	25.000 h	IP44	H05RN-F 3G1 / 2,5 m	220-240 V~ 50 / 60 Hz	2	3856024403788
308-533	2 x 30 W	2 x 3200 lm	6500 K	120°	25.000 h	IP44	H05RN-F 3G1 / 2,5 m	220-240 V~ 50 / 60 Hz	2	3856024403795
308-553	2 x 50 W	2 x 5400 lm	6500 K	120°	25.000 h	IP44	H05RN-F 3G1 / 2,5 m	220-240 V~ 50 / 60 Hz	2	3856024403818



Akumulatorski LED reflektori

Akumulatorski LED reflektori su namijenjeni korištenju u uvjetima gdje nemamo pristup izvoru električne energije. Ugrađene litijske baterije i kvalitetni LED sklopovi pružaju visoku razinu osvjetljenja i dugu autonomiju rada. Zahvaljujući praktičnom sklopivom dizajnu vrlo lako ćete ih pospremiti u ladicu, kutiju s alatom, ruksak za kampiranje ili automobil.

Rechargeable LED Floodlights

Rechargeable LED floodlights are intended to be used when there is no access to electricity. Built-in rechargeable Li-ion batteries and high quality LED provide a high level of illumination and long working autonomy. Thanks to practical self-folding design, you can easily keep them in a drawer, a toolbox, a camping backpack or a car.



Rotirajuća ručka za 180°
/ 180° Rotating handle



Power bank funkcija
/ Power bank function

IP44 Vodootporno kućište sa zaštićenim rubovima
IP44 Waterproof housing with protective edges

Sklopivi "slim" dizajn
Foldable slim design

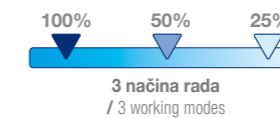

LED indikator baterije
/ Battery led indicator



"Slim" dizajn
/ Slim design



Šifra / Art. No.	Snaga / Power	Svjetlosni tok / Luminous flux	Temperatura svjetla / Color temperature	Stupanj zaštite / IP grade	Baterija / Battery	Kom./kutija / Pcs/ctn	EAN
308-312	10 W	1000 lm	6000 K	IP44	18650 3.7V 2000 mAh	24	3856024405829

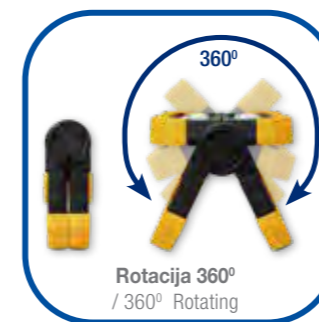

Rotacija 360°
/ 360° Rotating



Power bank funkcija
/ Power bank function

Sklopivi "slim" dizajn
Foldable slim design

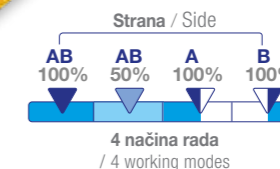

LED indikator baterije
/ Battery led indicator



Magnetni držač / Magnet holder



Čvrsto kućište sa zaštićenim rubovima
Robust housing with protective edges

Šifra / Art. No.	Snaga / Power	Svjetlosni tok / Luminous flux	Temperatura svjetla / Color temperature	Stupanj zaštite / IP grade	Baterija / Battery	Kom./kutija / Pcs/ctn	EAN
308-313	10 W	900 lm	6500 K	IP44	18650 3.7V 5000 mAh	6	3856024405911

Radne i prenosive svjetiljke

Commel radne i prenosive svjetiljke su jednostavno i praktično rješenje kada Vam nedostaje svjetlosti u radionici, garaži ili na kampiranju. Ovisno o njihovoj primjeni i Vašim specifičnim potrebama, možete odabrati između onih koje rade na napajanje iz električne mreže, prenosivih punjivih ili pak onih koje se pune sunčevom svjetlosti.

Inspection and Portable Lamps

Commel inspection lamps are a simple and practical solution when you need more light in a workshop, garage or at a campsite. Depending on their application and your specific needs, you can choose between those operating on power supply, power rechargeable ones or even solar rechargeable ones.



- **USB punjač, Senzorski prekidač**
USB charger, Sensor switch
- **Uključivanje i isključivanje jednostavnim pokretom ruku**
Turning the lamp ON or OFF by simple hand wave



Šifra / Art. No.	Snaga / Power	Svjetlosni tok / Luminous flux	Stupanj zaštite / IP grade	Kabel / Cable	Autonomija / Autonomy	Nazivni napon / Input voltage	Kom./kutija / Pcs/ctn	EAN
401-212	5 W	350 lm	IPx5	USB	4 h	Li-ion 3.7 V, 800 mAh	10	3856024402705



- **USB punjač, Senzorski prekidač**
USB charger, Sensor switch
- **Uključivanje i isključivanje jednostavnim pokretom ruku**
Turning the lamp ON or OFF by simple hand wave



Šifra / Art. No.	Snaga / Power	Svjetlosni tok / Luminous flux	Stupanj zaštite / IP grade	Kabel / Cable	Autonomija / Autonomy	Nazivni napon / Input voltage	Kom./kutija / Pcs/ctn	EAN
401-210	5 W	300 lm	IPx5	USB	3 h	Li-ion 3.7 V, 800 mAh	10	3856024402507



- **USB punjač, Senzorski prekidač**
USB charger, Sensor switch
- **Uključivanje i isključivanje jednostavnim pokretom ruku**
Turning the lamp ON or OFF by simple hand wave



Šifra / Art. No.	Snaga / Power	Svjetlosni tok / Luminous flux	Stupanj zaštite / IP grade	Kabel / Cable	Autonomija / Autonomy	Nazivni napon / Input voltage	Kom./kutija / Pcs/ctn	EAN
401-211	11 W	500 lm	IPx5	USB	2,5 h	Li-ion 3.7 V, 1500 mAh	10	3856024402699



- COB LED 3 W + SMD LED 3 W, USB punjač
COB LED 3 W + SMD LED 3 W, USB charger
- LED indikator stanja baterije, Snažan magnetski držač
Battery status LED indicator, Powerful magnetic holder

Šifra / Art. No.	Snaga / Power	Svjetlosni tok / Luminous flux	Stupanj zaštite / IP grade	Dimenzije / Dimensions	Nazivni napon / Input voltage	Baterija / Battery	Kom. /kutija / Pcs/ctn	EAN
401-020	3 W + COB LED 3 W	250 lm	IP44	27 x 19 x 162 mm	5 V 1 A	Lithium 3.7 V 1200 mAh	50	3858890449921

MULTIFUNKCIJSKA MINI LED SVJETILJKA
MULTIFUNCTIONAL MINI LED LAMP

4 Načina rada
/ 4 Working modes



Kompaktan dizajn / Compact design



Utor za stalak / Rack slot



Otvarač za boce / Bottle opener



Karabiner / Carabiner



Magnetni držač / Magnet holder



Sklopivi stalak / Foldable stand



Šifra / Art. No.	Snaga / Power	Svjetlosni tok / Luminous flux	Temperatura svjetla / Color temperature	Stupanj zaštite / IP grade	Dimenzije / Dimensions	Baterija / Battery	Kom. /kutija / Pcs/ctn	EAN
401-021	5 W	500 lm	6500 K	IP44	60 x 45 x 20 mm	Lithium 3.7 V 500 mAh	100	3856024405812



- USB punjač
LED indikator stanja baterije
USB charger
Battery status LED indicator
- Snažan magnetski držač
Mogućnost rotacije 360°
Powerful magnetic holder
360° rotation capability

Šifra / Art. No.	Snaga / Power	Svjetlosni tok / Luminous flux	Stupanj zaštite / IP grade	Dimenzije / Dimensions	Nazivni napon / Input voltage	Baterija / Battery	Kom. /kutija / Pcs/ctn	EAN
401-015	COB LED 10 W	580 lm	IP44	34 x 378 mm	5 V 1 A	Lithium 3.7 V 2000 mAh	50	3858890449914



Rotacija 360°
/ 360° Rotating



Metalna kuka
/ Metal hanger



LED indikator baterije
/ Battery LED indicator

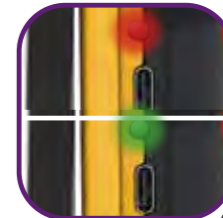

Magnetni držač / Magnet holder



Sekundarno svjetlo / Second light



Crveno svjetlo / Red light

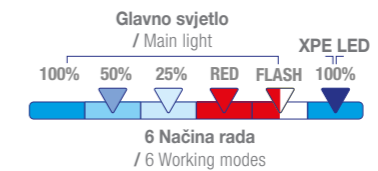

Šifra / Art. No.	Snaga / Power	Svjetlosni tok / Luminous flux	Temperatura svjetla / Color temperature	Stupanj zaštite / IP grade	Dimenzije / Dimensions	Baterija / Battery	Kom. /kutija / Pcs/ctn	EAN
401-016	10 W	800 lm	6500 K	IP44	28 x 36 x 148 mm	Lithium 3.7 V 1800 mAh	100	3856024405942

- Metalna zaštitna košara
Metal protective grille



Šifra / Art. No.	Snaga / Power	Tip grla / Bulb socket	Stupanj zaštite / IP grade	Kabel / Cable	Nazivni napon / Input voltage	Kom./kutija / Pcs/ctn	EAN
340-010	max 60 W	E27	IP20	H05RN-F 2x0,75 / 5m	220-240 V~ 50 Hz	8	3858890442564



- 3 razine osvjetljenja: 20% ; 50% ; 100%
Do 20 h neprekidnog rada

3 light modes: 20%, 50% and 100%
Up to 20 h of continuous operation

- Električna mreža za hvatanje komaraca
Vodootporna – IPX6, praktična kuka za vješanje

Mosquito killer grid, Waterproof – IPX6, practical hanger



Šifra / Art. No.	Snaga / Power	Svjetlosni tok / Luminous flux	Stupanj zaštite / IP grade	Baterija / Battery	Kom./kutija / Pcs/ctn	EAN
401-711	1 W	180 lm	IPX6	Li-Polymer 3.7 V 2000 mAh	20	3858890448382



- PVC zaštitna košara
PVC protective grille



Šifra / Art. No.	Snaga / Power	Tip grla / Bulb socket	Stupanj zaštite / IP grade	Kabel / Cable	Nazivni napon / Input voltage	Kom./kutija / Pcs/ctn	EAN
0885	max 60 W	E27	IP20	H05RN-F 2x0,75 / 5m	220-240 V~ 50 Hz	8	3859888558588



- 2 načina punjenja: solarni panel ili USB punjač
Dodatni izvor napajanja za elektroničke uređaje – power bank
Do 10 h neprekidnog rada, praktična sklopiva ručica

2 charging ways: solar panel or USB charging
Power bank – additional power source for electronic devices
Up to 10 h of continuous operation, practical foldable handle

- 3 u 1: prenosiva ručna svjetiljka + kamp svjetiljka + SOS svjetiljka
2 razine osvjetljenja + SOS signalno svjetlo

3 in 1: flashlight + camping lamp + SOS emergency lamp
2 light modes + SOS flashing

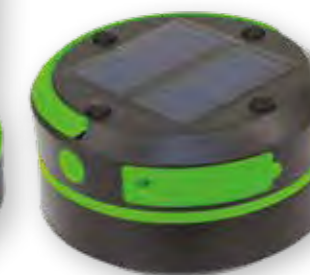

Šifra / Art. No.	Snaga / Power	Svjetlosni tok / Luminous flux	Baterija / Battery	Kom./kutija / Pcs/ctn	EAN
401-712	1 W	65 lm	Lithium 3.7 V 800 mAh	20	3858890448399

Noćna svjetla

Jednostavno pretvorite bilo koju utičnicu u izvor svjetla. Commel noćna svjetla pružaju diskretno osvjetljenje u noćnim satima, a najčešće se upotrebljavaju za osvjetljavanje dječjih soba, hodnika ili stubišta. Zahvaljujući ugrađenom fotosenzoru, svjetlo će se automatski uključivati i isključivati, ovisno o razini ambijentalnog osvjetljenja.

Night Lights

Simply turn any socket into a light source. Commel night lights provide discreet lighting at nighttime hours. They are most commonly used to illuminate children's rooms, hallways or staircases. Thanks to a built-in photosensor, a nightlight will automatically switch on and off, depending on ambient brightness.

Commel®



NOĆNO SVJETLO S PROJEKTOROM
NIGHT LIGHT WITH PROJECTOR



Šifra / Art. No.	Snaga / Power	Nazivni napon / Input voltage	Kom./Kutija / Pcs./ctn	EAN
390-203	0.7 W	220-240 V ~ 50 Hz	10	3856024403382



Ugrađeni fotosenzor automatski uključuje i isključuje svjetlo, ovisno o razini ambijentalnog osvjetljenja.

A built-in photosensor automatically switches on and off a nightlight, depending on ambient brightness.

Šifra / Art. No.	Snaga / Power	Nazivni napon / Input voltage	Kom./Kutija / Pcs./ctn	EAN
390-201	0.4 W	220-240 V ~ 50 Hz	20	3858890440676

Detektori pokreta i luksomati

Detektori pokreta i luksomati predviđeni su za automatizaciju upravljanja rasvjetnim tijelima i električnim uređajima. Kutovi detekcije, razni načini ugradnje i dometa kao i različita tehnologija detekcije pokreta omogućuju da svatko pronađe svoj idealan detektor pokreta ili luksomat.

Motion Detectors and Photocell Sensors

Motion detectors and photocell sensors are designed for automation of light fixtures and electrical appliances. They come in different varieties of detection angles, ways of installation, detection ranges as well as with different motion detection technologies, so you can find a perfect motion detector or photocell sensor for yourself.



INFRACRVENI DETEKTORI POKRETA

INFRARED MOTION DETECTORS



Šifra / Art. No.	Boja / Color	Kut detekcije / Detection angle	Dometa detekcije / Detection range	Nazivno opterećenje / Rated load	Suparni zaštite / IP grade	Nazivni napon / Input voltage	Kom./kutija / Pcs/ctn	EAN
311-151	bijela / white	360°	12 m	1200 W	IP20	220-240 V~ 50 Hz	50	3858883835250



Šifra / Art. No.	Boja / Color	Kut detekcije / Detection angle	Dometa detekcije / Detection range	Nazivno opterećenje / Rated load	Suparni zaštite / IP grade	Nazivni napon / Input voltage	Kom./kutija / Pcs/ctn	EAN
311-101	bijela / white	360°	6 m	1200 W	IP20	220-240 V~ 50 Hz	50	3858883835236
311-102	crna / black	360°	6 m	1200 W	IP20	220-240 V~ 50 Hz	50	3858883835243



Šifra / Art. No.	Boja / Color	Kut detekcije / Detection angle	Dometa detekcije / Detection range	Nazivno opterećenje / Rated load	Suparni zaštite / IP grade	Nazivni napon / Input voltage	Kom./kutija / Pcs/ctn	EAN
311-105	bijela / white	360°	6 m	2000 W	IP20	220-240 V~ 50 Hz	50	3858890447217



Šifra / Art. No.	Boja / Color	Kut detekcije / Detection angle	Dometa detekcije / Detection range	Nazivno opterećenje / Rated load	Suparni zaštite / IP grade	Nazivni napon / Input voltage	Kom./kutija / Pcs/ctn	EAN
311-201	bijela / white	360°	6 m	1200 W	IP20	220-240 V~ 50 Hz	50	3858883835274



Šifra / Art. No.	Boja / Color	Kut detekcije / Detection angle	Dometa detekcije / Detection range	Nazivno opterećenje / Rated load	Suparni zaštite / IP grade	Nazivni napon / Input voltage	Kom./kutija / Pcs/ctn	EAN
310-101	bijela / white	180°	12 m	1200 W	IP44	220-240 V~ 50 Hz	50	3858883835212
310-102	crna / black	180°	12 m	1200 W	IP44	220-240 V~ 50 Hz	50	3858883835229
310-103	srebrna / silver	180°	12 m	1200 W	IP44	220-240 V~ 50 Hz	50	3858890440874

MIKROVALNI DETEKTOR POKRETA
MICROWAVE MOTION DETECTOR



Mikrovalni (radarski) detektor pokreta je opremljen senzorima visoke osjetljivosti i predstavlja najkvalitetnije rješenje za automatizirano uključivanje priključenih uređaja ili rasvjetnih tijela. Za detekciju pokreta nije potrebna optička vidljivost jer mikrovalni signal prolazi kroz tanke stijenke zidova ili staklo, pa je zbog toga pogodan za montažu unutar kućišta svjetiljke, u spuštene stropove ili razvodne kutije.

Microwave motion detector is equipped with high sensitivity sensors and it is the best solution for automated switching on/off of connected devices or lighting fixtures. Motion detection does not require optical visibility because microwave signal passes through thin walls or glass and is therefore suitable for mounting inside a lamp housing, dropped ceilings or junction boxes.



Ugradnja u kutiju Ø 60 mm
Mounting in Ø 60 mm wall backbox

Šifra / Art. No.	Boja / Color	Kut detekcije / Detection angle	Dometa detekcije / Detection range	Nazivno opterećenje / Rated load	Suparni zaštite / IP grade	Nazivni napon / Input voltage	Kom./kutija / Pcs/ctn	EAN
312-101	bijela / white	160°	9 m	500 W	IP20	220-240 V~ 50 Hz	100	3858890440881



Šifra / Art. No.	Boja / Color	Kut detekcije / Detection angle	Dometa detekcije / Detection range	Nazivno opterećenje / Rated load	Suparni zaštite / IP grade	Nazivni napon / Input voltage	Kom./kutija / Pcs/ctn	EAN
313-101	bijela / white	360°	8 m	500 W	IP20	220-240 V~ 50 Hz	100	3858890440898



SENZORSKI PREKIDAČ
SENSOR SWITCH



Senzorski prekidač se koristi za uključivanje i isključivanje svjetla jednostavnim pokretom ruke. Opremljen je senzorom kratkog dometa koji kod svake detekcije pokreta naizmjenično uključuje i isključuje priključeno rasvjetno tijelo.

The sensor switch is used to turn the light on and off with a simple hand movement. Equipped with a short-range sensor that switches the connected lighting fixture on and off at each motion detection.



Šifra / Art. No.	Dometa detekcije / Detection range	Nazivno opterećenje / Rated load	Nazivna struja / Rated current	Suparni zaštite / IP grade	Nazivni napon / Input voltage	Kom./kutija / Pcs/ctn	EAN
311-205	5-6 cm	500 W	5 A	IP20	220-240 V~ 50 Hz	100	3858890447613

LUKSOMATI
PHOTOCELL SENSORS

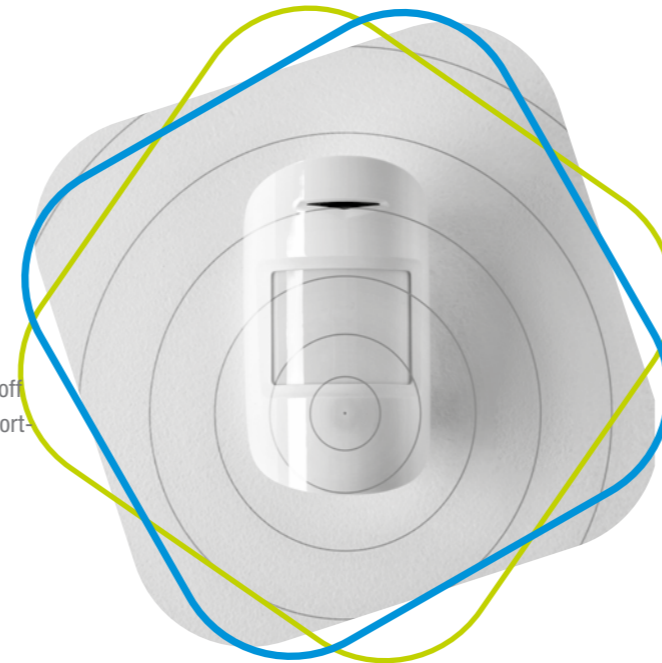

Šifra / Art. No.	Nazivna struja / Rated current	Suparni zaštite / IP grade	Nazivni napon / Input voltage	Kom./kutija / Pcs/ctn	EAN
314-101	6 A	IP44	220-240 V~ 50 Hz	100	3858890443431

Šifra / Art. No.	Nazivna struja / Rated current	Suparni zaštite / IP grade	Nazivni napon / Input voltage	Kom./kutija / Pcs/ctn	EAN
314-201	10 A	IP44	220-240 V~ 50 Hz	100	3858890443448



Commel®

Grla i pribor za rasvjetu

Ova grupa proizvoda obuhvaća PBT i keramička grla različitih namjena, kao i spojni pribor za montažu rasvjetnih tijela.



Bulb Sockets and Lighting Accessories

This product group includes PBT and ceramic bulb sockets for various purposes, as well as fittings for lighting fixtures installation.

PBT GRLA
PBT BULB SOCKETS



Šifra / Art. No.	Boja / Color	Baza / Base	Maks. temperatura / Max. temperature	Materijal kućišta / Housing material	Dimenzije / Dimensions	Nazivni napon / Voltage	Maks. opterećenje / Max. load	Kom./kutija / Pcs/ctn	EAN
016-105	bijela / white	E14	210 °C	PBT	26 x 56 mm	250 V ~	2 A	50	3858890449846
016-115	crna / black	E14	210 °C	PBT	26 x 56 mm	250 V ~	2 A	50	3858890449853
016-101	bijela / white	E27	210 °C	PBT	38.5 x 59 mm	250 V ~	4 A	50	3858890449808
016-111	crna / black	E27	210 °C	PBT	38.5 x 59 mm	250 V ~	4 A	50	3858890449815

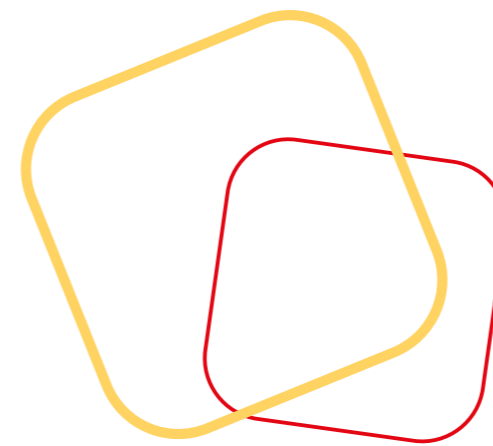

Šifra / Art. No.	Boja / Color	Baza / Base	Maks. temperatura / Max. temperature	Materijal kućišta / Housing material	Dimenzije / Dimensions	Nazivni napon / Voltage	Maks. opterećenje / Max. load	Kom./kutija / Pcs/ctn	EAN
016-106	bijela / white	E14	210 °C	PBT	43 x 55 mm	250 V ~	2 A	50	3858890449860
016-116	crna / black	E14	210 °C	PBT	43 x 55 mm	250 V ~	2 A	50	3858890449877
016-102	bijela / white	E27	210 °C	PBT	57 x 59 mm	250 V ~	4 A	50	3858890449822
016-112	crna / black	E27	210 °C	PBT	57 x 59 mm	250 V ~	4 A	50	3858890449839

GRLO E27 S KABELOM
E27 BULB SOCKET WITH CABLE



Šifra / Art. No.	Boja / Color	Materijal kućišta / Housing material	Maks. temperatura / Max. temperature	Dužina kabela / Cable length	Nazivni napon / Voltage	Maks. opterećenje / Max. load	Kom./kutija / Pcs/ctn	EAN
016-703	bijela / white	PBT	210°C	17 cm	250 V ~	2 A	25	3856024406765
016-704	crna / black	PBT	210°C	17 cm	250 V ~	2 A	25	3856024406772

GRLO GU10
GU10 BULB SOCKET



Šifra / Art. No.	Boja / Color	Materijal kućišta / Housing material	Dužina vodiča / Wire length	Nazivni napon / Voltage	Maks. opterećenje / Max. load	Kom./kutija / Pcs/ctn	EAN
016-401	bijela / white	keramika / ceramic	9 cm	250 V ~	2 A	50	3856024402248

KERAMIČKA GRLA
CERAMIC BULB SOCKETS

Šifra / Art. No.	Baza / Base	Materijal kućišta / Housing material	Maks. temperatura / Max. temperature	Dimenzije / Dimensions	Nazivni napon / Voltage	Maks. opterećenje / Max. load	Kom./kutija / Pcs/ctn	EAN
016-135	E40	Keramika / Ceramic	400 °C	54 x 69 mm	750 V ~	16 A	100	3858890449907



Šifra / Art. No.	Baza / Base	Materijal kućišta / Housing material	Maks. temperatura / Max. temperature	Dimenzije / Dimensions	Nazivni napon / Voltage	Maks. opterećenje / Max. load	Kom./kutija / Pcs/ctn	EAN
016-131	E27	Keramika / Ceramic	400 °C	40 x 46 mm	250 V ~	4 A	400	3858890449884



Šifra / Art. No.	Baza / Base	Materijal kućišta / Housing material	Maks. temperatura / Max. temperature	Dimenzije / Dimensions	Nazivni napon / Voltage	Maks. opterećenje / Max. load	Kom./kutija / Pcs/ctn	EAN
016-132	E27	Keramika / Ceramic	400 °C	40 x 46 mm	250 V ~	4 A	400	3858890449891





Ovaj katalog je promotivni materijal i isključivo je informativnog karaktera.
Commel - Zagreb d.o.o. zadržava pravo izmjene bez prethodne najave.
Zagreb, 2024.

This catalogue is promotional material made for informational purposes only.
Commel - Zagreb d.o.o. reserves the right to make changes without notice.
Zagreb, 2024.

